



Urban Green Growth Seminar, BI, Nydalen, Oslo
23.05.2019

From organic waste and residues to valuable bio-based fuels and products

Julien Meyer

Department for Environmental Industrial Processes

Outline

➤ **Challenges of growing urban areas**

Waste and residues from urban areas

**Solving the waste problem and
creating value**

The biogas value chain

Solid waste incineration

Closing the loop using bio-CO₂

Growing urban areas

- Today, 55% of the world's population lives in urban areas (4.2 billion in 2018)
- This proportion is expected to increase to 68% by 2050
- 90% of this increase is taking place in Asia and Africa

Source: United Nations



Tokyo, Japan



New Dehli, India

Challenges of growing urban areas

- **Sustainable urbanization** is key to successful development
- Many countries will face challenges in meeting the needs of their growing urban populations, including for
 - housing
 - transportation
 - energy systems
 - other infrastructures like waste handling
- **Waste handling in urban area has to be part of the solution**

Source: United Nations



Lagos, Nigeria



Sao Paulo, Brasil



Sao Paulo, Brasil

Waste and residues from urban areas

- Sewage (waste water)
- Municipal Solids Waste (MSW)
 - Food
 - Paper and cardboard
 - Glass
 - Plastics
 - Metals
 - Garden waste
 - Wood
 - Textiles
 - Rubber
- Waste from nearby industries
 - Food, beverage, agricultural industries ++

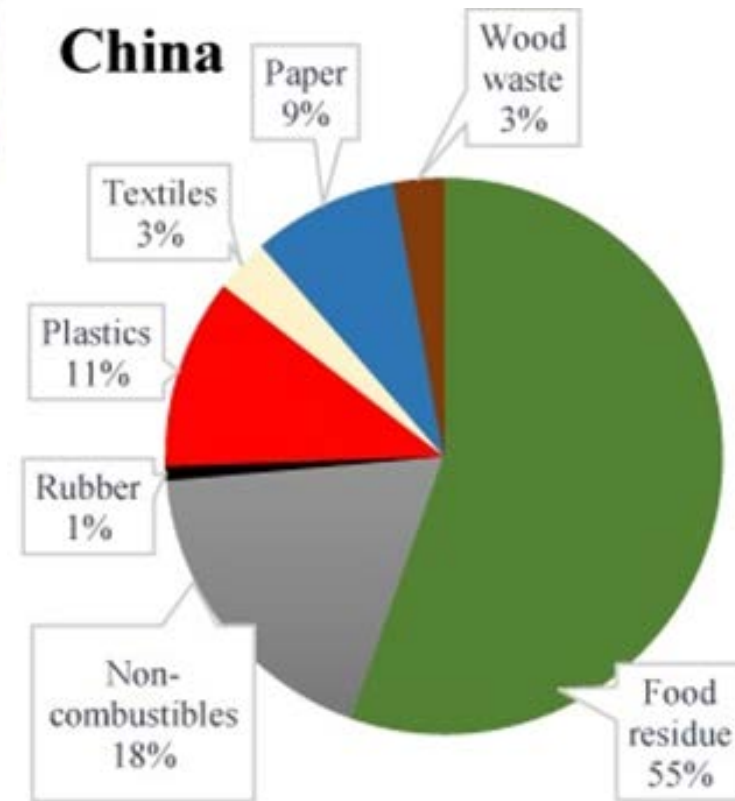
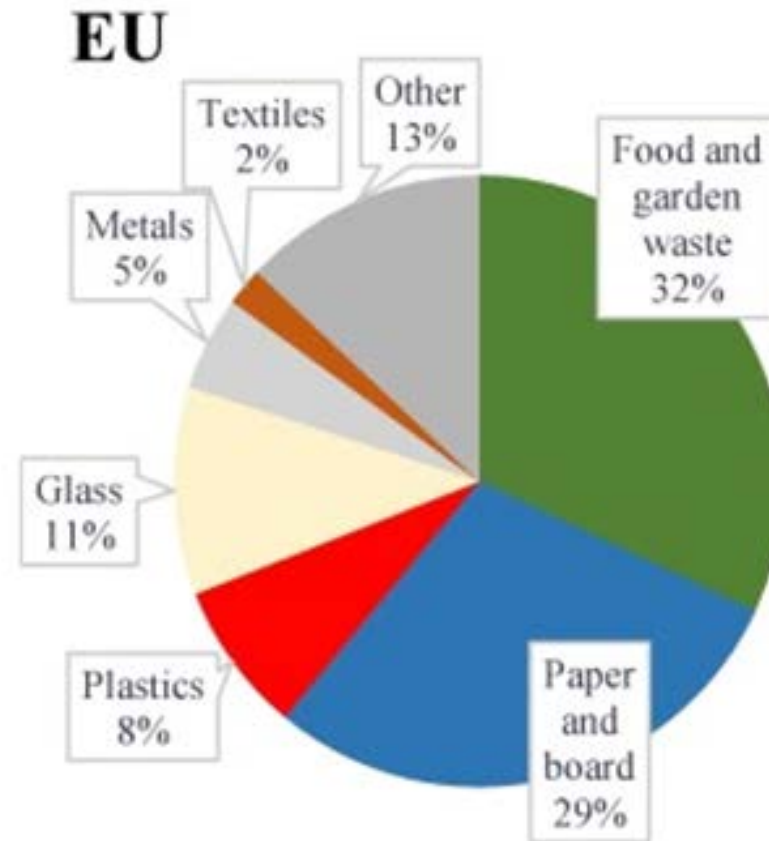

Solving the waste problem *and* creating value

- To meet sustainability,
 - **Avoid landfilling**
 - Reduce the carbon footprint of cities and their emissions to air
 - Create value
- The **Waste to Energy** approach meets these requirements
 - Heat and electricity for households
 - Biofuels for transportation
 - Bio-products for recycling
- The challenge is to put in place a proper **waste collection and sorting system**

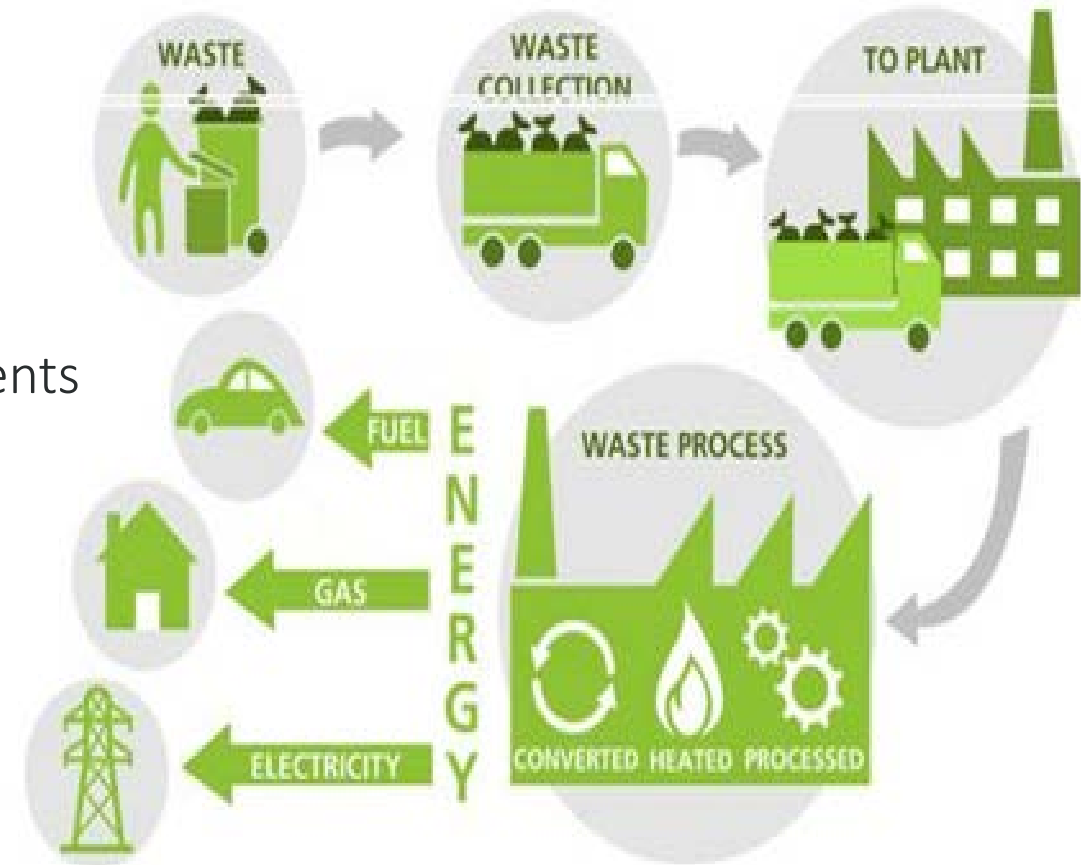

The biogas value chain

- Biogas is produced in a close system in anaerobic digestors or bioreactors
- Typical biogas composition is 60% CH₄ and 40% CO₂
- Biogas is typically produced from
 - Sewage sludge
 - Food, animal and agriculture waste

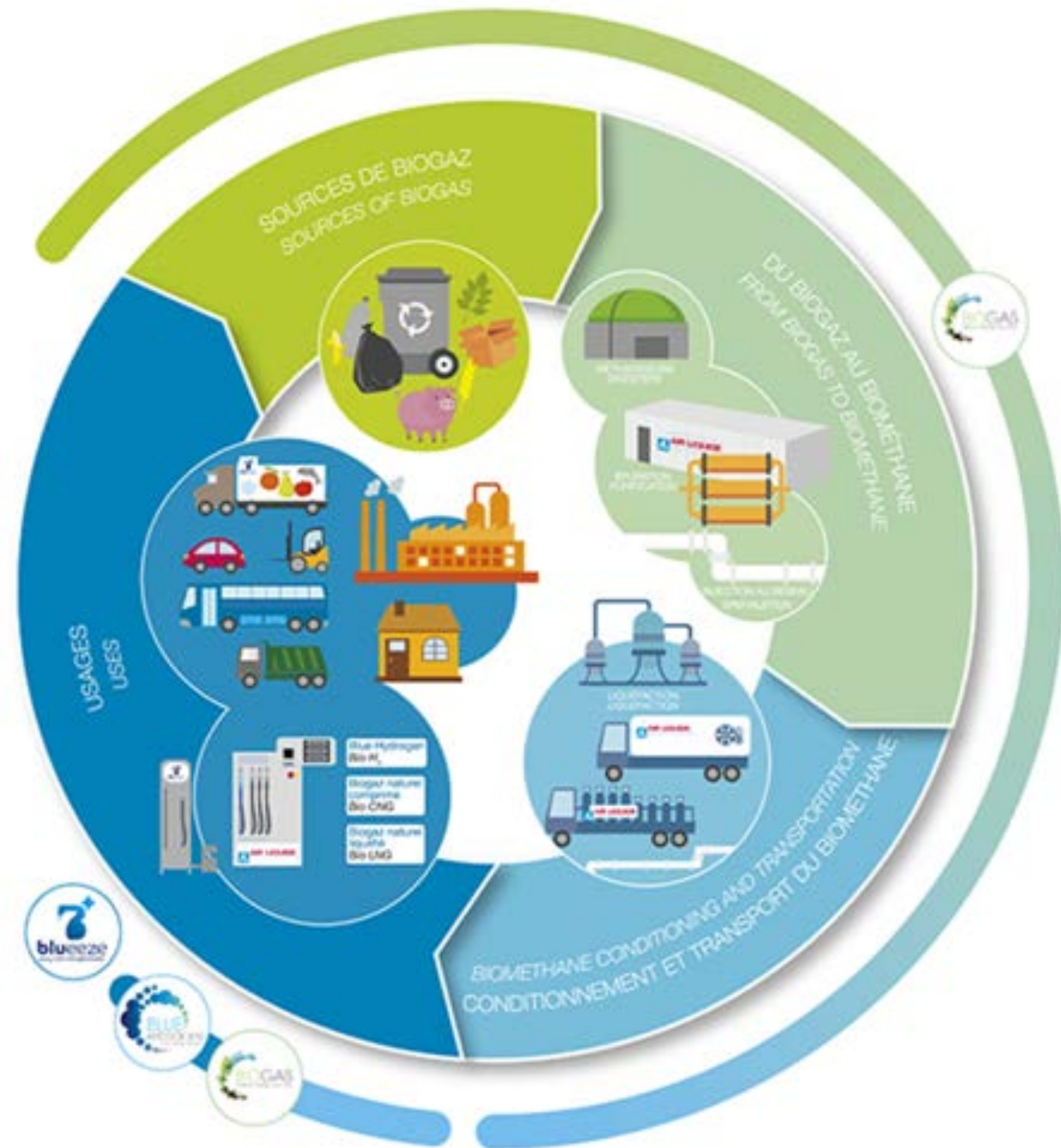

The biogas value chain

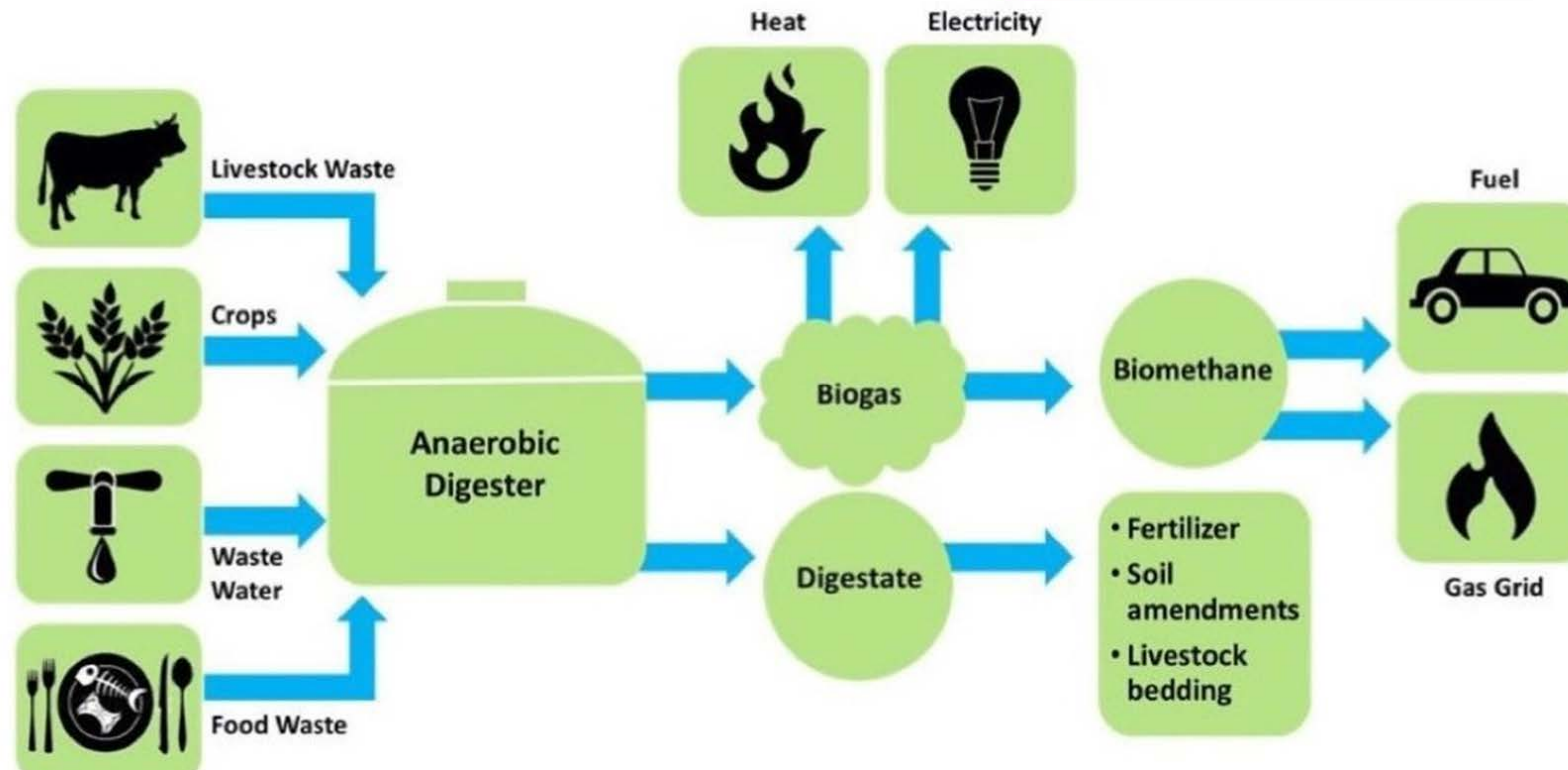

The biogas value chain

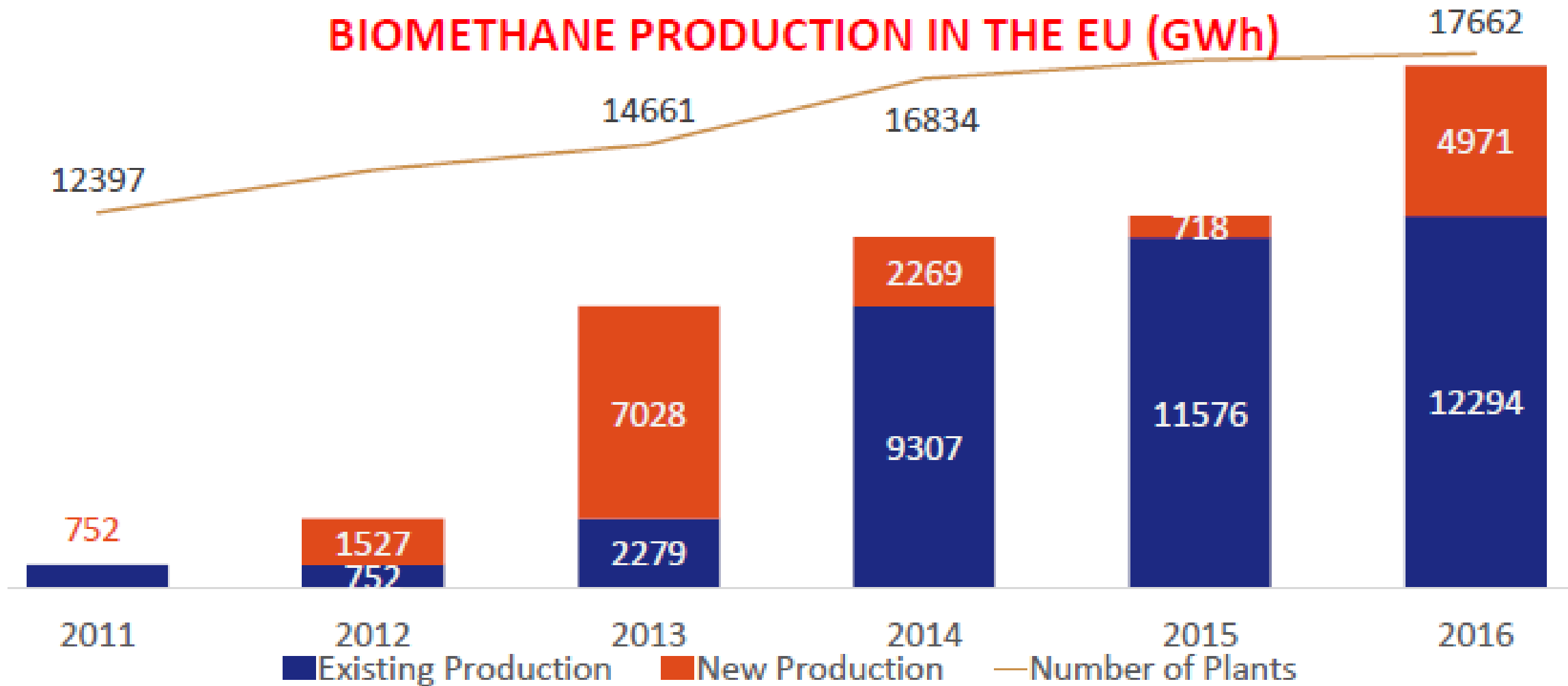

Other uses for biogas/biomethane

- Biomethane can be used as a **substitute for fossil natural gas** and therefore contribute to **reduce the carbon footprint** of products produced from natural gas
- One of these products is **hydrogen (H₂)**
- Conversion of biogas/biomethane to H₂ can contribute to the production of **green hydrogen** and to the **early decentralized implementation** of this market
- The use of green H₂ in the transportation sector in Fuel Cell Electric Vehicles (FCEV) will allow to **increase the efficiency (+10-15%)** and to **reduce NOx emissions** in urban areas



Conversion of biogas/biomethane to hydrogen

- Uses the **reforming route**
- Requires gas cleaning and usually an additional upgrading step
- Converts methane to green H_2 and bio- CO_2
- H_2 purification step is necessary

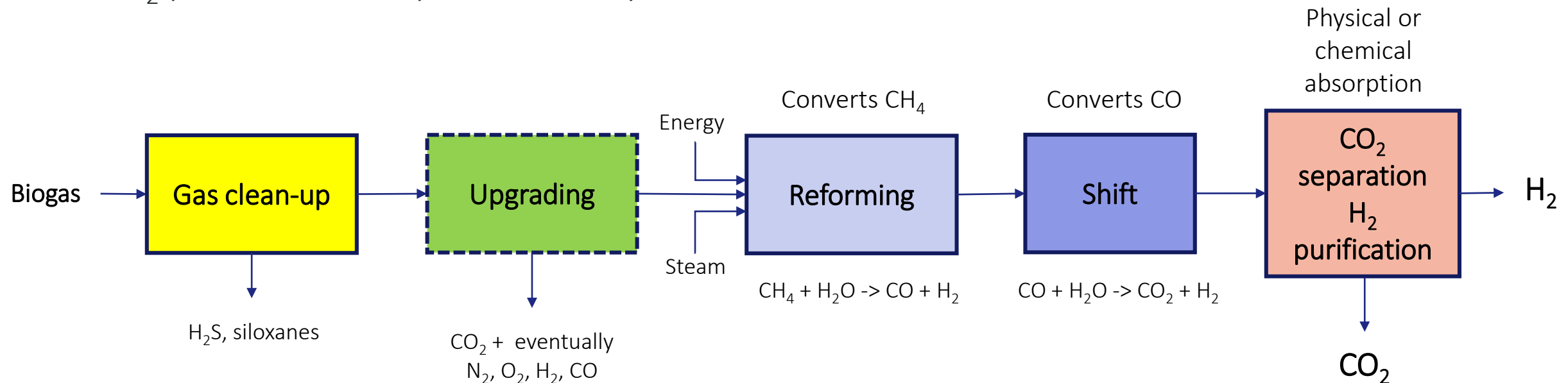

Conversion of digestate from anaerobic digestion

- Uses the **pyrolysis route** (heating without the presence of oxygen)
- Produces valuable gas, bio-oil and bio-char
- Combined with reforming and cracking, pyrolysis converts residual organic matter to green H_2 , bio- CO_2 , bio-fuels and bio-char

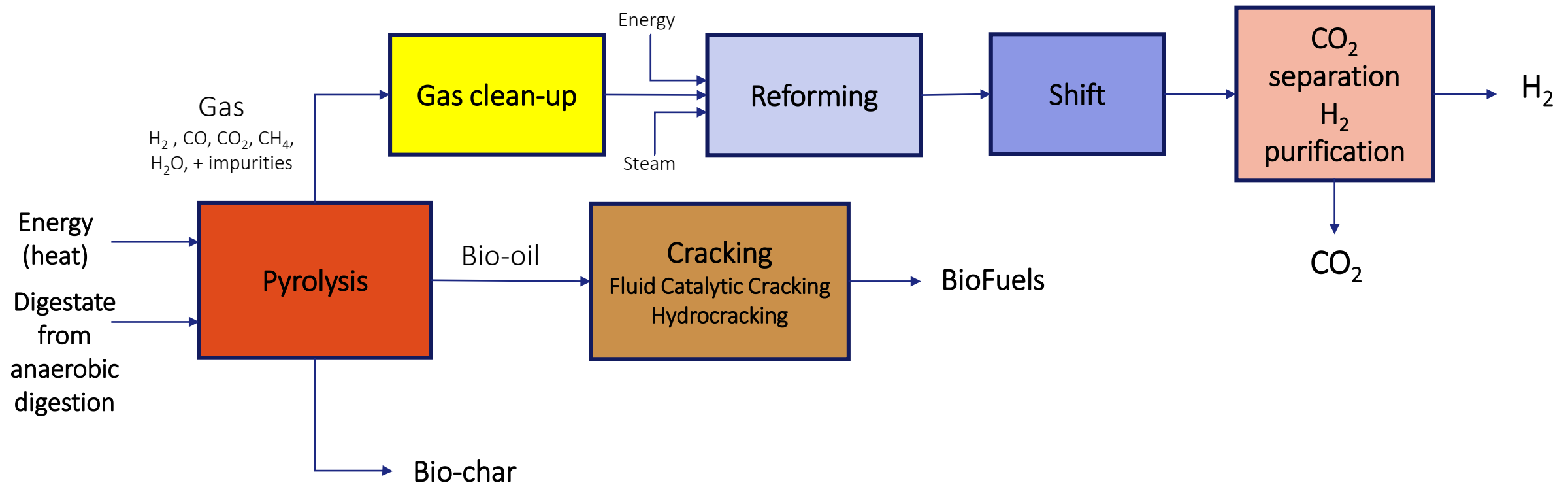

Methanation of bio-CO₂

- Converts bio-CO₂ to synthetic methane by reacting it with hydrogen
- Hydrogen produced from excess renewable power
- Methanation can also be applied to convert bio-CO₂ contained in biogas
- Use of synthetic methane as green chemical for **substitution of fossil natural gas**

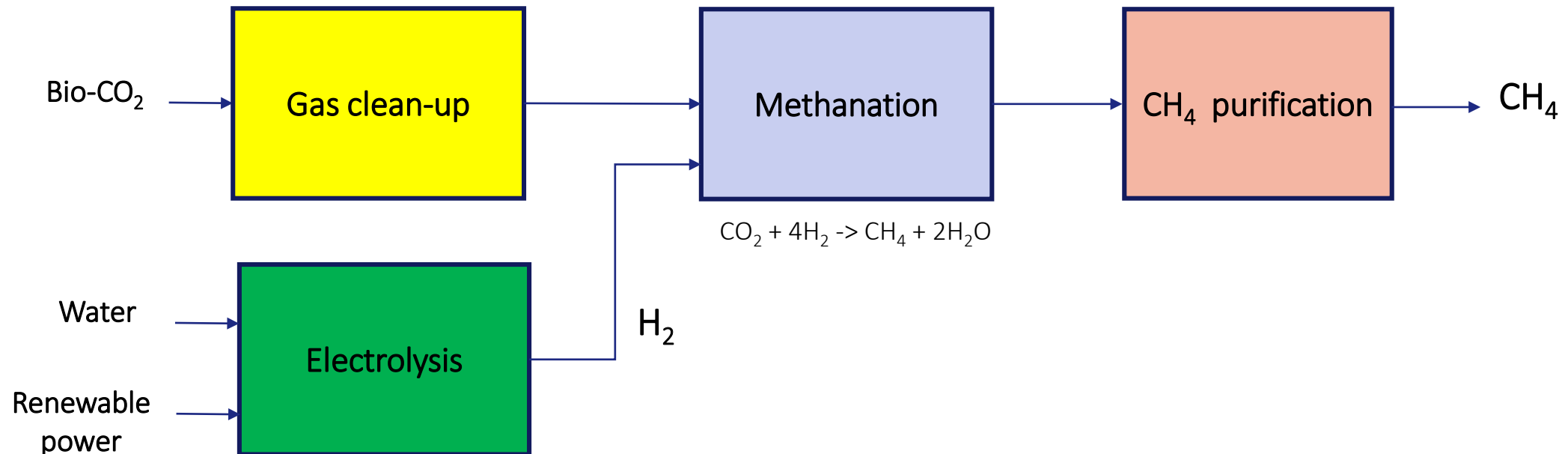

Closing the loop using the bio-CO₂

- Using bio-CO₂ generated from waste will allow closing the loop contributing to **sustainable development** in urban areas and **value creation**
- Use of bio-CO₂ in greenhouses
 - food to waste to food: vegetables
- Use of bio-CO₂ to produce synthetic methane or methanol for petro-chemical and refining industries
 - plastics to waste to plastics: PE, PP, PVC
- Challenges
 - Building the value chains
 - Value chain economy: reduce the cost of technologies, policies

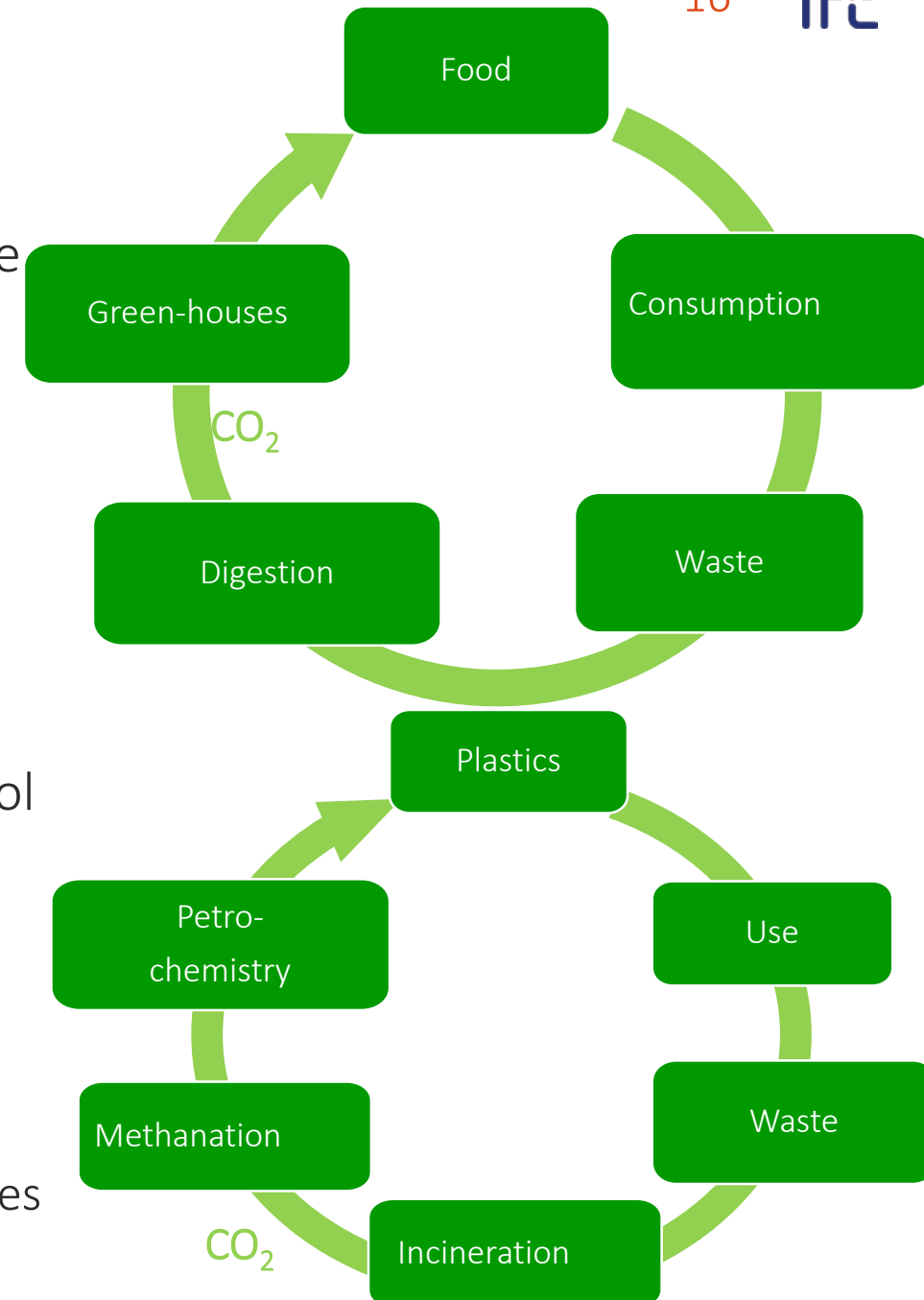

IFE's research in the field

- Hydrogen production from biogas with CO₂ capture
 - Development of a new reforming process using high temperature CO₂ capture with solid sorbents: **Sorption-Enhanced Reforming (SER)**
 - Extract more than twice the amount of bio-CO₂ than conventional technology
- Production of bio-methanol from biomass
- Enhanced methanation
 - Technological developments to improve the efficiency of the methanation process and reduce its cost (catalyst, membranes, reactor design)

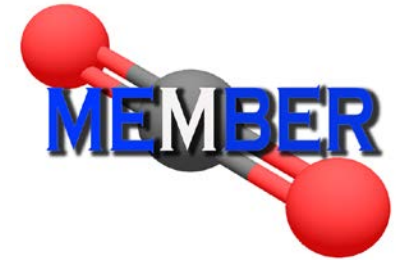

<https://member-co2.com/content/home>



<http://www.converge-h2020.eu>



Thanks for your attention

Julien Meyer
Senior Researcher

julien.meyer@ife.no