

Unemployment and Endogenous Reallocation over the Business Cycle ^{*†}

Carlos Carrillo-Tudela [‡] Ludo Visschers [§]

April 2014

Abstract

This paper studies unemployed workers' decisions to change occupations, and their impact on fluctuations in aggregate unemployment and its underlying duration distribution. We develop an analytically and computationally tractable stochastic equilibrium model with heterogeneous labor markets. In this model three different types of unemployment arise: search, rest and reallocation unemployment. We document new evidence on unemployed workers' gross occupational mobility and use it to calibrate the model. We show that rest unemployment is the main driver of unemployment fluctuations over the business cycle and causes cyclical unemployment to be highly volatile. The resulting unemployment duration distribution generated by the model responds realistically to the business cycle, creating substantial longer-term unemployment in downturns. Finally, rest unemployment also makes our model simultaneously consistent with procyclical occupational mobility of the unemployed, countercyclical job separations into unemployment and a negatively-sloped Beveridge curve.

Keywords: Unemployment, Business Cycle, Rest, Search, Occupational Mobility.

JEL: E24, E30, J62, J63, J64.

*We would like to thank Arpad Abraham, Jim Albrecht, Anja Bauer, Melvyn Coles, Juanjo Dolado, Mike Elsby, Andrés Erosa, Bart Hobijn, Leo Kaas, John Kennen, Matthias Kredler, Ricardo Lagos, Ben Lester, Jeremy Lise, Rafael Lopes de Melo, Iourii Manovskii, Claudio Michelacci, Espen Moen, Dale Mortensen, Fabien Postel-Vinay, Morten Ravn, Thijs van Rens, Victor Rios-Rull, Jean-Marc Robin, Shouyong Shi, Rob Shimer, Ija Trapeznikova, Gianluca Violante, Randy Wright and Eran Yashiv for their very helpful comments, suggestions and discussions. We would also like to thank participants of the CESifo workshop "Labor Market Search and Policy Applications", the Labor Market Dynamics and Growth conferences, the NBER Summer Institute 2011 (RSW), VI REDg - Barcelona (2011), SED Meetings and SaM workshops, the CESifo Macroeconomics and Survey Data conference, the Kiel/Richmond Fed Workshop 2013, and in seminars at Oxford, Carlos III, Essex, the St. Louis Fed, CEMFI (MadMac), Konstanz, Surrey, VU Amsterdam, UCL, Queen Mary, Edinburgh, Tinbergen Institute, Sheffield, Uppsala, Tel Aviv, Toronto, Western Ontario, Southampton and UC Louvain. We would also like to thank Rahel Felder who provided excellent research assistance with the data analysis. The usual disclaimer applies.

[†] Carlos Carrillo-Tudela acknowledges financial support from the UK Economic and Social Research Council (ESRC), award reference ES/I037628/1. Ludo Visschers acknowledges financial support from the Juan de la Cierva Grant and Project Grant ECO2010-20614 from the Spanish Ministry of Science and Innovation, and a grant from the Bank of Spain's Programa de Investigación de Excelencia. He also thanks the CESifo institute and the St. Louis Fed for their hospitality. First version: June 2010.

[‡] University of Essex, CESifo and IZA. Correspondence: Department of Economics, University of Essex, Wivenhoe Park, Colchester, CO4 3SQ, UK; cocarr(at)essex(dot)ac(dot)uk.

[§] The University of Edinburgh, Universidad Carlos III Madrid and CESifo. Correspondence: School of Economics, The University of Edinburgh, 30 Buccleuch Place, Edinburgh, UK, EH8 9JT; or, Department of Economics, Universidad Carlos III de Madrid, Calle Madrid, 126, 28903 Getafe (Madrid), Spain; lvissche(at)eco(dot)uc3m(dot)es.

1 Introduction

The Great Recession has revived an important debate about the extent and nature of unemployment across different labor markets.¹ In this paper we construct and quantitatively assess an equilibrium business cycle model, in which different types of unemployment arise in different labor markets. We use this model to analyse how unemployed workers' reallocation decisions change with individual and aggregate conditions, creating labor market turnover and fluctuations in the aggregate unemployment rate and the underlying duration distribution.

We build on Alvarez and Shimer (2011a), who study the relative importance of rest and search unemployment. They consider a steady state economy with different industries, each characterised by a competitive labor market.² In our model we consider an out-of-steady-state economy, by introducing aggregate productivity shocks. We distinguish between 'search', 'reallocation' and 'rest' unemployment, by including search frictions in labor markets. In addition, we study how differences in workers' productivities within an occupation affect their reallocation decisions when unemployed, by considering an economy with several occupations. In our model workers' occupational productivities increase through learning-by-doing and are subject to shocks that are specific to the individual within an occupation. This approach builds on Kambourov and Manovskii (2009a), who show the importance of workers' occupation-specific productivities for reallocation decisions.³

Search unemployment in our model is caused by frictions that make it time-costly to find a vacancy. *Rest unemployment* is caused by workers who chose to remain in their occupations, even though currently there are no employment opportunities for them. *Reallocation unemployment* is caused by frictions that make it time-consuming to find a different occupation with sufficiently promising labor market conditions. The extent to which each type of unemployment arises depends on the persistence and volatility of workers' productivities within an occupation, the degree of reallocation frictions across occupations and the aggregate state of the economy. The fluctuations of aggregate unemployment are then determined by the cyclical characteristics of search, rest and

¹See, for example, Şahin, et al. (2012) and Herz and Van Rens (2011) who measure the extent of mismatch; and Elsby, et al. (2010) and Barnichon and Figura (2013), who measure the extent to which matching efficiency has decreased during the Great Recession.

²See also Jovanovic (1987), Hamilton (1988) and Gouge and King (1997) who, as Alvarez and Shimer (2011a), study search and rest unemployment. In these models the term search unemployment denotes the unemployment experienced by workers who move across different industries.

³An important difference between our approach and that of Kambourov and Manovskii (2009a) and Alvarez and Shimer (2011a) is that we consider idiosyncratic shocks to workers' occupational productivities, and not sector-wide (occupation or industry) shocks, as the main determinant of workers' reallocation decisions. In Appendix C we provide evidence that motivates this approach. Our evidence is consistent with Shimer (2007), who argues that occupational mobility at business cycle frequencies is primarily for idiosyncratic reasons. It is also consistent with Kroft et al. (2013), who show that the rise in long-term unemployment during and after the Great Recession is not driven by a subset of occupations or industries, but occurs in all major occupations and industries. Jovanovic and Moffitt (1990) and Auray et al. (2014) show that workers' mobility decisions across industries are primarily driven by idiosyncratic shocks and not by industry-wide shocks. Dvorkin (2013) shows that net mobility across industries cannot account for the majority of the fluctuations in aggregate unemployment.

reallocation unemployment.

We show that rest unemployment is the most important driver of aggregate unemployment fluctuations. It is also able to rationalise the cyclical behavior of the labor market along many other important dimensions. In a downturn, for example, a large proportion of workers who have a low productivity in their occupation become rest unemployed, now facing no immediate job prospects. Simultaneously, the existing pool of rest unemployed workers find it less profitable to reallocate, further increasing the size of aggregate unemployment and decreasing the overall job finding rate. In the calibration, these changes in rest unemployment lead to cyclical fluctuations of the aggregate unemployment rate that are quantitatively in line with the data. Underlying these fluctuations, the cyclical responses of the model's aggregate job separation and job finding rates are also quantitatively in line with the data. Moreover, the increase in rest unemployment in downturns generates realistic cyclical changes in the unemployment duration distribution. The model also preserves the main features for which the canonical Diamond-Mortensen-Pissarides (DMP) model is empirically successful. That is, the changes in rest unemployment are able to generate a high correlation between the job finding rate and labor market tightness and a strongly downward-sloping Beveridge curve, similar to the empirical ones.

We also show that rest unemployment and occupational human capital accumulation can rationalise young and prime-aged workers' unemployment and reallocation outcomes. Quantitatively, the model can replicate these workers' unemployment duration distributions, their average occupational mobility rates, and the positive relationship between the two. Over the business cycle, the model generates the empirical cyclical volatility of these workers' job separation and job finding rates.

A key aspect of our model is that workers with different productivities face different labor markets within their occupations. Search frictions within these labor markets imply that there is a non-trivial job separation decision. This results in a job separation productivity cutoff. Because job separations are privately efficient in this setting, firms do not post vacancies on labor markets below this separation cutoff. Reallocation decisions are also summarised by a reallocation productivity cutoff.

The cyclical behavior of our model is determined by the relative position of the separation and reallocation cutoffs, as well as the rate at which they vary with aggregate productivity. Only when the separation cutoff is above the reallocation cutoff, search, rest and reallocation unemployment coexist within an occupation. Search unemployment arises in those labor markets above the separation cutoff. Rest unemployment arises in those labor markets between the separation and reallocation cutoffs. Workers in labor markets below the reallocation cutoff, move to another occupation in search for better employment opportunities. How the cutoffs vary with aggregate productivity then further shapes the response of the three types of unemployment to aggregate productivity shocks.

To quantitatively evaluate the relative importance of the three types of unemployment, we use

the Survey of Income and Program Participation (SIPP) to generate new evidence on the gross occupational mobility patterns of the unemployed. We use these mobility patterns together with the observed duration distribution of unemployment spells, averaged over the entire duration of our sample, to estimate the main parameters of our model. Namely, the autocorrelation and variance of workers' productivity process within an occupation, and a reallocation cost that captures the extent of reallocation frictions. The calibration yields a persistent productivity process with sizeable innovations (relative to the aggregate productivity process), as well as significant reallocation frictions. Together they imply that 68% of aggregate unemployment is accounted for by rest unemployment. Search unemployment accounts for 22% and reallocation unemployment for the remainder 10%.

Rest unemployment is prominent in the calibration because it can reproduce a number of observed unemployment and occupational mobility patterns in a mutually consistent way, while search and reallocation unemployment by themselves cannot. First, rest unemployment is fully able to reconcile the coexistence of large occupational mobility flows and the substantial proportion of long-term unemployment among workers who find a job in their previous occupations. Second, it allows the model to match the large proportion of unemployed workers who found a job in their previous occupation, but change occupations after becoming unemployed a second time. Third, rest unemployment can explain how unemployment incidence is concentrated in a subset of workers.

Our model is related to the empirical work by Barnichon and Figura (2013), who highlight the importance of worker heterogeneity across labor markets to understand unemployment fluctuations. Taking as given observed vacancy and unemployment levels, they estimate a matching function that incorporates (i) dispersion in local labor market conditions such that tight labor markets coexist with slack ones; and (ii) differences in workers' levels of employability and search intensity. They show that both dimensions explain well the fluctuations of the aggregate job finding rate in the US. Our model captures these two dimensions as equilibrium outcomes through its labor market structure and the existence of search, rest and reallocation unemployment. In addition, the large gross flows of occupational mobility among the unemployed observed in the data implies that, in our model, workers' reallocation decisions generate further job creation responses that help rationalize the many labor market patterns described earlier.

Robin (2011), Chassamboulli (2013) and Murtin and Robin (2013) have also stressed that differences in workers' employability levels are an important driving force behind unemployment fluctuations. These authors consider time-invariant heterogeneity in workers' productivities.⁴ In our model, workers' productivities change over time and are affected by their reallocation choices. Rest unemployment arises as an outcome of these reallocation choices and is the main driver of unemployment fluctuations.

⁴Other studies have highlighted the importance of firm heterogeneity in explaining unemployment fluctuations. Recent example are Kaas and Kircher (2012), Lise and Robin (2012), Moscarini and Postel-Vinay (2013) and Coles and Mortensen (2012). Menzio and Shi (2011) highlight the role of heterogeneity in firm-worker matches.

Wiczer (2013) develops a similar model to ours. He analyses the role of aggregate productivity and occupation-wide shocks on workers' reallocation decisions and long-term unemployment. Here, we do not consider shocks to occupations as a whole, but focus on idiosyncratic shocks to the worker's productivity within his occupation.⁵ These shocks are persistent and affect the worker's outcomes both in employment and unemployment, until the worker decides to switch occupations. Unlike in his model, the interaction between aggregate and idiosyncratic shocks is sufficient to replicate the overall volatility of cyclical unemployment, while remaining consistent with the cyclical behavior of long-term unemployment.

Rest unemployment in our model is closely related to the unemployment generated in mismatch or stock-flow matching models. Shimer (2007), for example, defines mismatch unemployment as those workers who remain attached to a local labor market even though there are currently no jobs for them. In stock-flow matching models, as in Coles and Smith (1998), unemployed workers wait for new jobs to arrive, as existing vacancies do not offer suitable employment opportunities. Shimer (2007) and Ebrahimi and Shimer (2010) have shown that these types of unemployment can generate sizeable fluctuations in aggregate unemployment. However, these types of models typically do not consider workers' reallocation and job separation flows, and when considered they are assumed to be exogenous. In contrast, in our model these two margins are endogenous and play a crucial role in determining rest unemployment and aggregate unemployment fluctuations.

The rest of the paper is organised as follows. In the next section we present our motivating evidence on occupational mobility. In Sections 3-5 we develop the model and discuss implications of the theory. Sections 6-8 contain our quantitative analysis and Section 9 concludes. Proofs are relegated to the Appendix or to the Supplementary Appendix.

2 Occupational Mobility Through Unemployment

A key dimension of the paper is to link the gross occupational mobility of the unemployed to individual and aggregate unemployment outcomes. We begin our analysis by studying unemployed workers' gross occupational mobility using the SIPP for the period 1986-2011. Our sample includes only workers that transition from employment to unemployment and back, without any transitions into inactivity. We compare each worker's occupation before and after unemployment, using 'major' (one-digit) occupational groups. We define workers who re-enter employment in a different occupation as 'occupational movers' and workers who do not change occupations as 'occupational stayers'. In Appendix C we motivate our focus on gross occupational mobility through unemployment and relate our findings to the literature on occupational mobility. In the

⁵As mentioned earlier, in Appendix C we motivate of this approach. In addition to Wiczer (2013), Pilossoph (2012) considers a model with search frictions within aggregate industries in which workers reallocation's decisions are affected by preferences shocks, but workers choose to which industry to reallocate. Her model has two important difference with our framework: it assumes exogenous separations and delivers countercyclical reallocations. See also Mehrotra and Sergeyev (2013) and Dvorkin (2013) for a related approach. Lkhagvasuren (2012) considers a model with search frictions within geographically distinct labor markets and endogenous mobility across these markets. However, his focus is on steady-state analysis.

Supplementary Appendix we provide further details of the sample used and the construction of our occupational mobility measures.

We establish the following new facts. (i) The extent of occupational mobility is high, increases with unemployment duration and decreases with age. (ii) A large proportion of occupational movers and stayers change occupations after a subsequent unemployment spell. (iii) Occupational mobility of the unemployed is procyclical. As mentioned earlier, our model will show that rest unemployment is able to reconcile these patterns, while generating realistic cyclical fluctuations of aggregate unemployment, job separations and long-term unemployment.

Table 1: Proportion of completed unemployment spells ending with an occupation change

Major Occupational Groups					
	all	male	female	high school	college
young (20 < age ≤ 30y)	0.53	0.54	0.51	0.54	0.53
prime (35 < age ≤ 55)	0.45	0.45	0.44	0.47	0.45
all working ages	0.50	0.51	0.49	0.52	0.49

The Extent of Occupational Mobility Table 1 describes the proportion of unemployed workers who found a job in a different occupation for various demographic groups. It shows that workers are, on average, equally likely to stay in their occupations or to change occupations after a spell of unemployment.⁶ We also find that, across gender and educational levels, the proportion of occupational movers is higher for young than for prime-aged workers.

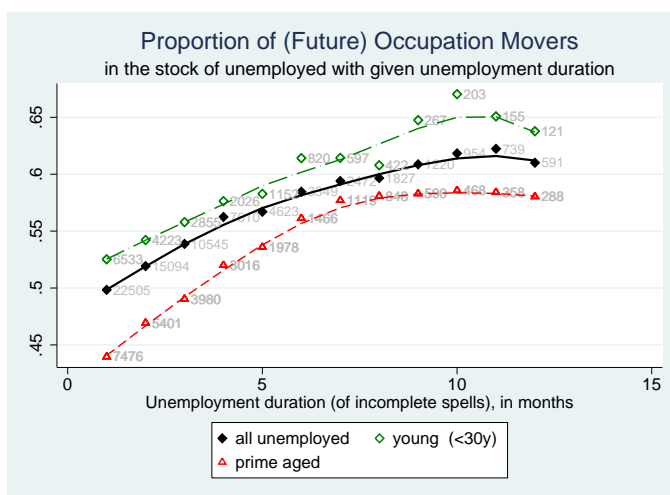

Figure 1: Extent of occupational mobility by unemployment duration

Figure 1 shows that the proportion of occupational movers increases moderately with unemployment duration (though this relation becomes non-monotone close to 12 months duration). As

⁶As argued in more detail in Appendix C, we find that the extent of occupational mobility is high in all major occupational categories and is not driven by a subset of them.

a result, the proportion of workers who will be occupational stayers remains substantial, even at long unemployment durations.

Repeat Mobility From all those occupational stayers that became unemployed once again, we find that 38% of these workers change occupations after concluding their second unemployment spell. This percentage is lower for prime-aged workers (35%) and higher for young workers (44%). Likewise, from all those occupational movers that became unemployed once again, we find that 56% of these workers moved yet to another occupation. This percentage is also lower for prime-aged workers (54%) and higher for young workers (62%).

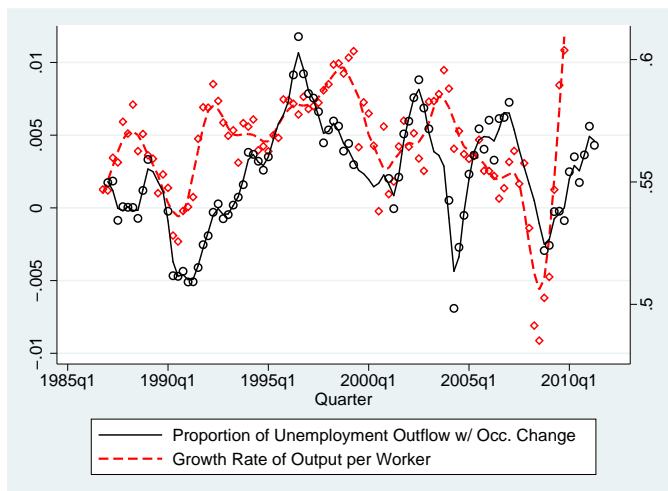

Figure 2: Moving average of the growth rate of output per worker and the log series of C_m

Business Cycle Patterns Finally consider the cyclical behavior of the proportion of occupational movers in the outflow from unemployment, C_m . Figure 2 shows a (centered) 5-quarters moving average of (log) C_m together with the growth rate of output per worker. It shows that the occupational mobility of the unemployed is procyclical, it tends to be higher when the economy is growing faster. Its correlation with the growth rate of output per worker is 0.36. Table 2 confirms this observation. It shows the volatility and autocorrelation of the cyclical components of the (log) C_m , as well as its correlations with the cyclical components of the job finding rate (f), unemployment rate (u), output (Y) and output per worker (y) series.⁷

We now construct a model in which the option for unemployed workers to reallocate to different occupations affects their individual unemployment outcomes. When aggregating these individual unemployment outcomes, the model will produce implications for the cyclical behavior of key unemployment statistics, such as those discussed above.

⁷Carrillo-Tudela, Hobijn and Visschers (2014) analyse data from the Current Population Survey, and likewise find procyclicality in the occupational mobility of the unemployed. Details on the construction of Table 2 can be found in the Supplementary Appendix.

Table 2: Composition and outflow rates of movers/stayers over the business cycle

	Cm	f	u	y	Y
Standard Deviation	0.028	0.097	0.129	0.009	0.016
Autocorrelation	0.850	0.928	0.966	0.695	0.871
Corr. w/ output/worker	0.256	0.453	-0.524	1.000	0.834
Correlation w/ u	-0.255	-0.773	1.000	-0.524	-0.816

3 Model

3.1 Framework

Time is discrete $t = 0, 1, 2, \dots$. There is a finite number of occupations indexed by $o = 1, \dots, O$. Within each occupation there is a mass of infinitely lived, risk-neutral workers. At any time t , within an occupation workers differ in two components that are occupation specific: an idiosyncratic productivity, z_t , and occupational human capital, x_h .⁸ Workers' z -productivities evolve over time following a common first-order stationary Markov process, where $F(z_{t+1}|z_t)$ denotes its transition law and $z_t, z_{t+1} \in [\underline{z}, \bar{z}]$, $\underline{z} > 0$ and $\bar{z} < \infty$. The z -productivity realizations affect a worker both in employment and in unemployment within his occupation. Workers accumulate occupational human capital through learning-by-doing. In any period t an employed worker with human capital level x_h , increases his human capital to x_{h+1} with probability $\chi(x_{h+1}|x_h)$, where $\chi(x_{h+1}|x_h) = 1 - \chi(x_h|x_h)$, $x_h < x_{h+1}$, $h = 1, \dots, H$ and $x_H < \infty$. For simplicity, a worker's human capital does not depreciate with unemployment.⁹ Any unemployed worker receives b each period.

There is also a mass of infinitely lived risk-neutral firms within an occupation. All firms are identical and operate under a constant return to scale technology, using labor as the only input. Each firm consists of only one job that can be either vacant or filled. The output of a worker with current productivity z_t and human capital x_h in any firm is given by the production function $y(p_t, z_t, x_h)$, where p_t denotes aggregate productivity. We assume p_t follows a first-order stationary Markov process with $p_t \in [\underline{p}, \bar{p}]$, $\underline{p} > 0$ and $\bar{p} < \infty$. The production function is strictly increasing in all of its arguments and it is continuous differentiable in the first two. All agents discount the

⁸A worker's idiosyncratic productivity captures occupation match-specific, industry and location components that determine this worker's productivity in his occupation and are orthogonal to occupational human capital. For example, it captures that the productivity of a chemical engineer working in the photo industry in Rochester, US, can differ from the productivity of another, equally experienced, chemical engineer working in the oil industry in Texas, US. Further, a worker's idiosyncratic productivity can change over time as a result of the evolution of the occupation match-specific, industry and location components.

⁹An implication of this assumption is that unemployed workers' reallocation decisions will be determined by the evolution of their z -productivities and not by the depreciation of their occupational human capital. This seems a reasonable abstraction in light of Figure 1, which suggests that occupational human capital depreciation does not have a prominent role in determining unemployed workers' reallocation decisions. If it had, we would observe young and prime-aged workers' occupational mobility rates converge at long unemployment durations. This is because human capital depreciation has a bigger impact on experienced workers relative to inexperienced workers, who have little human capital. In this figure, however, the difference between young and prime-aged workers' mobility rates hardly varies with unemployment duration.

future at rate β .

Matching A key assumption is that workers with different pairs (z, x_h) do not congest each other in the matching process. This assumption allows us to study business cycle behavior in a tractable way. As a result, an occupation is segmented into many labor markets, one for each pair (z, x_h) . Each labor market (z, x_h) has the DMP structure. A constant returns to scale matching function governs the meetings of unemployed workers and vacancies within each market. We assume that all labor markets have the same matching technology. Each of these labor markets exhibits free entry of firms, where posting a vacancy costs k per period.¹⁰ When the z -productivity of an unemployed worker with human capital x_h changes to z' , the relevant labor market for this worker would become (z', x_h) . Should an employed worker become unemployed the relevant labor market would be the one associated with his current z -productivity and human capital level x_h . Match break-up can occur with an exogenous (and constant) probability δ , but can also occur if the worker and the firm decide to do so. Once the match is broken, the firm has to decide to reopen the vacancy and the worker stays unemployed until the end of the period. In what follows we will often refer to z as the worker's labor market conditions, keeping the dependence on human capital implicit.

Reallocation Unemployed workers can also reallocate and search for jobs in a different occupation. The key assumption here is that workers do not know ex-ante the specific labor market conditions they will face in a new occupation and need to spend time and resources to find this out. A worker rationally expects that his labor market conditions in another occupation are drawn from a distribution $F(z)$. Reflecting the dominant importance of idiosyncratic factors in gross occupational mobility, we abstract from occupation-wide differences driving gross mobility and assume that the ex-ante expected $F(z)$ is the same for all occupations. In Appendix C we present evidence that motivates this assumption.

In particular, after paying a cost c , a worker realizes his z -productivity in a new occupation as a random draw from $F(z)$, which we take to be the ergodic distribution associated with the aforementioned Markov process $F(z_{t+1}|z_t)$. After observing his new z -productivity, the worker must sit out one period unemployed before deciding whether or not to reallocate once again. For simplicity, we assume no recall of z -productivities once the worker has left his occupation. Reallocation also involves the loss of a worker's accumulated human capital. The worker starts with human capital x_1 in the new occupation. A worker's z -productivity and occupational human capital then evolve as described above. Without loss of generality, we assume that each occupation has a $1/(O - 1)$

¹⁰Barnichon and Figura (2013) present evidence showing that the segmented labor market assumption provides a better representation of the matching process, compared to the aggregate labor market approach typically found in the search and matching literature (see Pissarides, 2001). One can obtain this labor market structure as an equilibrium outcome of a competitive search model in which firm post wage contracts in different sub-markets, each to attract unemployed workers with different productivities. Within a sub-market, a matching function then determines the meetings of workers and firms.

probability of being sampled.¹¹ In Section 8.2 we further discuss the motivation behind assuming random search across (o, z) pairs.

We highlight that our model exhibits positive gross mobility and zero net mobility across occupational groups. Reallocations are driven by a stationary shock process to workers' idiosyncratic productivities within an occupation, its interaction with human capital accumulation and aggregate productivity shocks.

Timing and state space The timing of the events is summarised as follows. At the beginning of the period the new values of p , z and x_h are realised. After these realisations, the period is subdivided into four stages: separation, reallocation, search and matching, and production. Let \mathcal{E}_t denote the joint productivity distribution of unemployed and employed workers over all occupations in period t . Let \mathcal{E}_t^j denote this distribution at the beginning of stage j . The state space for a worker currently characterised by (z_t, x_h) at the beginning of stage j is described by the vector $\Omega_t^j = \{es_t, o_t, p_t, z_t, x_h, \mathcal{E}_t^j\}$, where es_t captures the worker's employment status and o_t his occupational attachment.

We can show that the equilibrium decision rules have a relevant state space described solely by $\{p_t, z_t, x_h\}$ and workers' employment status. To keep notation complexity to a minimum, we present the agents' decision problems and the laws of motion of unemployed and employed workers using this state space. Note that $\{p_t, z_t, x_h\}$ are sufficient statistics for the evolution of a worker's productivity within his current occupation, and hence without loss of generality we can drop the occupational index, o_t , from a worker's labor market and from his decision problems. To further simplify notation we leave implicit the time subscripts, denoting the following period with a prime.

3.2 Agents Decisions

Worker's Problem Consider an unemployed worker currently characterised by the pair (z, x_h) in occupation o . The value function of this worker at the beginning of the production stage is given by

$$W^U(p, z, x_h) = b + \beta \mathbb{E}_{p', z'} \left[\max_{\rho(p', z', x_h)} \left\{ \rho(p', z', x_h) \left[-c + \int_{\tilde{z}}^{\bar{z}} W^U(p', \tilde{z}, x_1) dF(\tilde{z}) \right] + (1 - \rho(p', z', x_h)) \left[\lambda(\theta(p', z', x_h)) W^E(p', z', x_h) + (1 - \lambda(\theta(p', z', x_h))) W^U(p', z', x_h) \right] \right\} \right], \quad (1)$$

where $\theta(p, z, x_h)$ denotes the ratio between vacancies and unemployed workers currently in labor market (z, x_h) and $\lambda(\cdot)$ the associated job finding probability. The value of unemployment consists of the flow benefit of unemployment b , plus the discounted expected value of being unemployed

¹¹Our assumptions imply each occupation has the same size, set of z -productivities and probability of being chosen. One can make occupations differ in terms of their size, by changing the sampling distribution of occupations according to the transition matrices reported in the Supplementary Appendix without affecting our results.

at the beginning of next period's reallocation stage, where $\rho(p', z', x_h)$ takes the value of one when the worker decides to reallocate and zero otherwise. The term $-c + \int_{\underline{z}}^{\bar{z}} W^U(p', \tilde{z}, x_1) dF(\tilde{z})$ denotes the expected net benefit of reallocating and sampling a new productivity \tilde{z} in a different occupation. It is through this term that expected labor market conditions in other occupations affect the value of unemployment, and indirectly the value of employment, in the worker's current occupation. The reallocation decision is captured by the choice between the expected reallocation gains and the expected payoff of remaining in the current occupation. The latter is given by the expression within squared brackets in the second line of the above equation.

Now consider an employed worker currently characterised by the pair (z, x_h) in occupation o . The expected value of employment at the beginning of the production stage given wage $w(p, z, x_h)$ is described by

$$W^E(p, z, x_h) = w(p, z, x_h) + \beta \mathbb{E}_{p', z', x'} \left[\max_{d(p', z', x')} \left\{ (1 - d(p', z', x')) W^E(p', z', x') + d(p', z', x') W^U(p', z', x') \right\} \right], \quad (2)$$

where $x' = x_h$ if this worker does not increase his human capital and $x' = x_{h+1}$ if he does. The second term describes the worker's option to quit into unemployment in next period's separation stage. The job separation decision is summarised in $d(p', z', x')$, such that it take the value of δ when $W^E(p', z', x') \geq W^U(p', z', x')$ and the value of one otherwise.

Firm's Problem Consider a firm posting a vacancy in labor market (z, x_h) at the start of the search and matching stage. The expected value of a vacancy solves the Bellman equation

$$V(p, z, x_h) = -k + q(\theta(p, z, x_h)) J(p, z, x_h) + (1 - q(\theta(p, z, x_h))) V(p, z, x_h), \quad (3)$$

where $q(\cdot)$ denotes firms' probability of finding an unemployed worker and $J(p, z, x_h)$ denotes the expected value of a filled job. Free entry implies that $V(p, z, x_h) = 0$ for all those triples (p, z, x_h) that yield a $\theta(p, z, x_h) > 0$, and $V(p, z, x_h) \leq 0$ for all those (p, z, x_h) that yield a $\theta(p, z, x_h) \leq 0$. In the former case, the free entry condition simplifies (3) to $k = q(\theta(p, z, x_h)) J(p, z, x_h)$.

Now consider a firm employing a worker currently characterised by the pair (z, x_h) at wage $w(p, z, x_h)$. The expected lifetime discounted profit of this firm can be described recursively as

$$J(p, z, x_h) = y(p, z, x_h) - w(p, z, x_h) + \beta \mathbb{E}_{p', z', x'} \left[\max_{\sigma(p', z', x')} \left\{ (1 - \sigma(p', z', x')) J(p', z', x') + \sigma(p', z', x') V(p', z', x') \right\} \right], \quad (4)$$

where $\sigma(p', z', x')$ takes the value of δ when $J(p', z', x') \geq V(p', z', x')$ and the value of one otherwise. Further, $x' = x_h$ if the worker does not increase his human capital and $x' = x_{h+1}$ if he does.

Wages We assume that wages are determined by Nash Bargaining. Consider a firm-worker match currently associated with the pair (z, x_h) such that it generates a positive surplus. Nash Bargaining implies that the wage, $w(p, z, x_h)$, solves

$$(1 - \alpha) \left(W^E(p, z, x_h) - W^U(p, z, x_h) \right) = \alpha \left(J(p, z, x_h) - V(p, z, x_h) \right), \quad (5)$$

where $\alpha \in [0, 1]$ denotes the worker's exogenous bargaining power.

In what follows we impose the Hosios (1991) condition, such that $1 - \alpha = \eta(\theta(p, z, x_h))$, where $\eta(\cdot)$ denotes the elasticity of the job finding probability with respect to labor market tightness. This guarantees that firms post the efficient number of vacancies within labor markets. It will also guarantee that our decentralised economy is efficient as shown below in Proposition 2.

3.3 Worker Flows

The evolution of the number of workers is a result of optimal vacancy posting, and separation and reallocation decisions. Their evolution can be summarised by the following difference equations. The number of unemployed workers characterised by (z, x_h) in occupation o at the beginning of next period is given by

$$\begin{aligned} u'_o(z, x_h) dz &= \int_{\tilde{z}}^{\bar{z}} (1 - \lambda(\theta(p, \tilde{z}, x_h))) (1 - \rho(p, \tilde{z}, x_h)) u_o(\tilde{z}, x_h) dF(z|\tilde{z}) d\tilde{z} \quad (6) \\ &+ \int_{\tilde{z}}^{\bar{z}} d(p, \tilde{z}, x_h) e_o(\tilde{z}, x_h) dF(z|\tilde{z}) d\tilde{z} \\ &+ (\mathbf{1}_{h=1}) \left[\sum_{\tilde{o} \neq o} \sum_{h=1}^H \left[\int_{\tilde{z}}^{\bar{z}} \rho(p, \tilde{z}, \tilde{x}_h) u_{\tilde{o}}(\tilde{z}, \tilde{x}_h) d\tilde{z} \right] \right] \frac{dF(z)}{O-1}. \end{aligned}$$

The first term refers to all those workers in labor markets (\tilde{z}, x_h) that remained unemployed in occupation o during the current period and changed to (z, x_h) at the beginning of the next period. Conditional on staying in occupation o , this term captures those workers that did not find a job. This could be because no jobs were posted and $\lambda(\theta(p, z, x_h)) = 0$, or because they were unlucky and did not meet any new vacancies when $\lambda(\theta(p, z, x_h)) > 0$. The second term refers to those employed workers in labor markets (\tilde{z}, x_h) that became unemployed and changed to (z, x_h) at the beginning of the next period. By assumption, these workers do not participate in either the reallocation or matching stages and do not increase their human capital. The third term refers to all those unemployed workers in different occupations that sampled z and o when reallocating.¹² Since reallocation re-sets occupational human capital, the indicator function $\mathbf{1}_{h=1}$ takes the value of one when the labor market (z, x_h) is associated with x_1 and zero otherwise.

¹²To derive this term we have assumed that when a worker samples a new z in a different occupation, he arrives to the new occupation at the start of the following period. This assumption is made purely for convenience. It is made without a loss of generality since there are no decisions taken during the production stage and workers draw new z in an i.i.d fashion.

The number of employed workers characterised by (z, x_h) in occupation o at the beginning of the next period is given by

$$\begin{aligned}
e'_o(z, x_h)dz &= \chi(x_h|x_h) \int_{\underline{z}}^{\bar{z}} \lambda(\theta(p, \tilde{z}, x_h))(1 - \rho(p, \tilde{z}, x_h))u_o(\tilde{z}, x_h)dF(z|\tilde{z})d\tilde{z} & (7) \\
&+ \chi(x_h|x_h) \int_{\underline{z}}^{\bar{z}} (1 - d(p, \tilde{z}, x_h))e_o(\tilde{z}, x_h)dF(z|\tilde{z})d\tilde{z} \\
&+ (\mathbf{1}_{h>1}) \left[\chi(x_h|x_{h-1}) \int_{\underline{z}}^{\bar{z}} (1 - d(p, \tilde{z}, x_{h-1}))e_o(\tilde{z}, x_{h-1})dF(z|\tilde{z})d\tilde{z} \right].
\end{aligned}$$

The first term describes those unemployed workers in labor markets (\tilde{z}, x_h) that found a job in their same occupation o , did not increase their human capital and changed to (z, x_h) at the beginning of the next period. The second term describes those employed workers in occupation o that did not transit to unemployment or increased their human capital, and changed to (z, x_h) at the beginning of the next period. The third term describes those employed workers in occupation o that increased their human capital from x_{h-1} to x_h , and changed to (z, x_h) at the beginning of the next period. The indicator function $\mathbf{1}_{h>1}$ takes the value of one when the labor market (z, x_h) is associated with a value of $x_h > x_1$ and zero otherwise.

4 Equilibrium

We focus on equilibria in which the value functions and decisions of workers and firms in any occupation only depend on $\{p_t, z_t, x_h\}$ and workers' employment status. In this type of equilibria outcomes can be derived in two steps. In the first step, decision rules are solved independently of the distribution \mathcal{E} , using (1)-(4). Once those decision rules are determined, we fully describe the dynamics of \mathcal{E} , using the workers' flow equations, (6) and (7). Given this recursive structure, we label this type of equilibrium 'block recursive', borrowing the term from the directed search literature (see Menzio and Shi, 2011). We relegate all the proofs of this section to Appendix A.

Definition A Block Recursive Equilibrium (BRE) is a set of value functions $W^U(p, z, x_h), W^E(p, z, x_h), J(p, z, x_h)$, workers' policy functions $d(p, z, x_h), \rho(p, z, x_h)$ (resp. separation and reallocation decisions), firms' policy function $\sigma(p, z, x_h)$ (layoff decision), tightness function $\theta(p, z, x_h)$, wages $w(p, z, x_h)$, laws of motion of p, z and x_h for all occupations, and laws of motion for the distribution of unemployed and employed workers over all occupations, such that: (i) the value functions and decision rules follow from the firm's and worker's problems described in (1)-(4); (ii) labor market tightness $\theta(p, z, x_h)$ is consistent with free entry on each labor market, with zero expected profits determining $\theta(p, z, x_h)$ on labor markets at which positive ex-post profits exist; $\theta(p, z, x_h) = 0$ otherwise; (iii) wages solve (5); (iv) the flow equations (6) and (7) map initial distributions of unemployed and employed workers (respectively) over labor markets and occupations into next period's distribution of unemployed and employed workers over labor markets and occupations,

according to the above policy functions and exogenous separations.

Existence Consider the labor market characterised by (z, x_h) in occupation o . Let $M(p, z, x_h) \stackrel{def}{=} W^E(p, z, x_h) + J(p, z, x_h)$ denote the joint value of the match and consider the operator T that maps the value functions $M(p, z, x_h)$ and $W^U(p, z, x_h)$ into the same function space, where T is formally defined in Appendix A. To simplify the analysis that follows, we assume a Cobb-Douglas matching function as it implies a constant elasticity of the job finding probability with respect to θ . Abusing notation slightly, let such an elasticity be denoted by η .

A fixed point of the mapping T describes the problem faced by unemployed workers and firm-worker matches currently in this labor market. Further, since the identity of the occupation does not affect the value functions $M(p, z, x_h)$ or $W^U(p, z, x_h)$, a fixed point of T also describes the problem faced by agents in the decentralised economy. The task is to find a fixed point in two dimensions $(M(p, z, x_h), W^U(p, z, x_h))$, taking into account endogenous job separations and endogenous reallocations. These reallocations involve workers randomly sampling (o, z) pairs, making a decision to stay in an occupation with good enough labor market conditions for them. Thus, in our model reallocating workers cannot direct their search towards a particular labor market. However, the problem remains tractable because an unemployed worker does not carry his previous (o, z) pairs when reallocating. As a result, firms in a given labor market meet unemployed workers who all have the same outside option. Together with free-entry and constant returns to scale in production and matching, this means that tightness in any given labor market is pinned down independently of the distribution of workers, \mathcal{E} .

Assumption 1. $F(z'|z) < F(z'|\tilde{z})$, for all z, z' if $z > \tilde{z}$.

In the proof of Proposition 1 we use this assumption to show that the operator T is a contraction that maps $M(p, z, x_h)$ and $W^U(p, z, x_h)$ that are increasing in z into itself. Given this result and the Banach's Fixed Point Theorem, a unique fixed point $(M(p, z, x_h), W^U(p, z, x_h))$ of the mapping T exists. We can then derive all equilibrium value functions and decision rules from this fixed point. We have the following: $W^E(p, z, x_h) = M(p, z, x_h) - J(p, z, x_h)$ and $J(p, z, x_h) = \eta(M(p, z, x_h) - W^U(p, z, x_h)) = k/q(\theta(p, z, x_h))$. This implies that $W^E(p, z, x_h)$, $J(p, z, x_h)$ and $\theta(p, z, x_h)$ can be constructed from $M(p, z, x_h)$ and $W^U(p, z, x_h)$. By completing these steps we have existence and uniqueness of a block recursive equilibrium which are 'inherited' from the existence and uniqueness of the fixed point of the mapping T .

Proposition 1. *A BRE exists and it is the unique equilibrium.*

Using the mapping T and the insights of Proposition 2, below, we also show the more general uniqueness proof.¹³

¹³To derive the properties of T and existence and uniqueness of a BRE we do not require the Hosios (1991) condition to hold within labor markets. However, this condition is needed to prove efficiency and hence that the BRE identified here is also the unique equilibrium in the class of recursive equilibria.

Efficiency The social planner, currently in the production stage, solves the problem of maximising total discounted output by choosing separations, reallocations, and vacancy creation decisions for each pair (z, x_h) across all occupations, at any period t . Namely,

$$\max_{\{d(\cdot), \rho(\cdot), v(\cdot)\}} \mathbb{E} \left[\sum_{t=0}^{\infty} \beta^t \sum_{o=1}^O \sum_{h=1}^H \int_{\bar{z}} [u_{o,t}(z, x_h)b + e_{o,t}(z, x_h)y(p_t, z, x_h) - (c\rho(\cdot)u_{o,t}(z, x_h) + kv_{o,t}(\cdot))] dz \right]$$

subject to initial conditions (p_0, \mathcal{E}_0) , and the laws of motion (6) and (7). The planner's choices depend on the entire state space $\{p_t, z_t, x_h, \mathcal{E}_t\}$, where $v_{o,t}(p_t, z, x_h, \mathcal{E}_t)$ denotes the number of vacancies posted in the labor market (z, x_h) in occupation o at time t . Labor market tightness is then given by $\theta_{o,t}(p_t, z, x_h, \mathcal{E}_t) = v_{o,t}(p_t, z, x_h, \mathcal{E}_t)/(1 - \rho(p_t, z, x_h, \mathcal{E}_t))u_{o,t}(z, x_h)$. As with tightness, the planner's choice variables $\rho(p_t, z, x_h, \mathcal{E}_t)$ and $d(p_t, z, x_h, \mathcal{E}_t)$ are continuous choice variables in $[0, 1]$: the planner can decide on the proportion of workers in labor market (z, x_h) to separate or reallocate.

Proposition 2. *The equilibrium identified in Proposition 1 is constrained efficient.*

We use the entire state space to show that the solution to the planner's problem in the general state space coincides with the solution to the decentralised economy problem in the space (p, z, x_h) . Therefore, the planner's decisions (when considering $\theta(\cdot)$ instead of $v(\cdot)$) only depend on (p, z, x_h) and not on \mathcal{E} . The social planner's value functions are linear in the number of unemployed and employed on each labor market. The remaining dependence on p, z and x_h is the same as the one derived from the fixed point of T . The key remaining step is to ensure that a worker's value of reallocation coincides with the planner's value of reallocating this worker. Given this, the outcome at the matching stage is also efficient because we imposed the Hosios' (1991) condition. It then follows that the cyclical pattern of workers' occupational mobility in the model is also efficient.

5 Implications

We now turn to explore the main implications of our theory: the occurrence of rest unemployment and the cyclicity of workers' reallocations and job separations. To keep the intuition as clear as possible we study a version of our model without occupational human capital accumulation, setting $x_h = 1$ for all h . This implies that, within an occupation, workers differ only by their idiosyncratic productivity, z , and labor market segmentation is done along this dimension. Agents' value functions are still given by equations (1)-(4), but now with state space (p, z) .

Using this simplified framework, we show that the workers' reallocation and job separation decisions are characterised by reservation z -productivity cutoff functions. By studying the relative position of these functions, we then explore the conditions under which rest unemployment arises. By studying their slopes, we gain insights on the cyclical properties of separations and reallocations in our model. All the proofs of this section can be found in Appendix B. In the calibration section, we show that the same properties as derived below apply to the more general setup considered there.

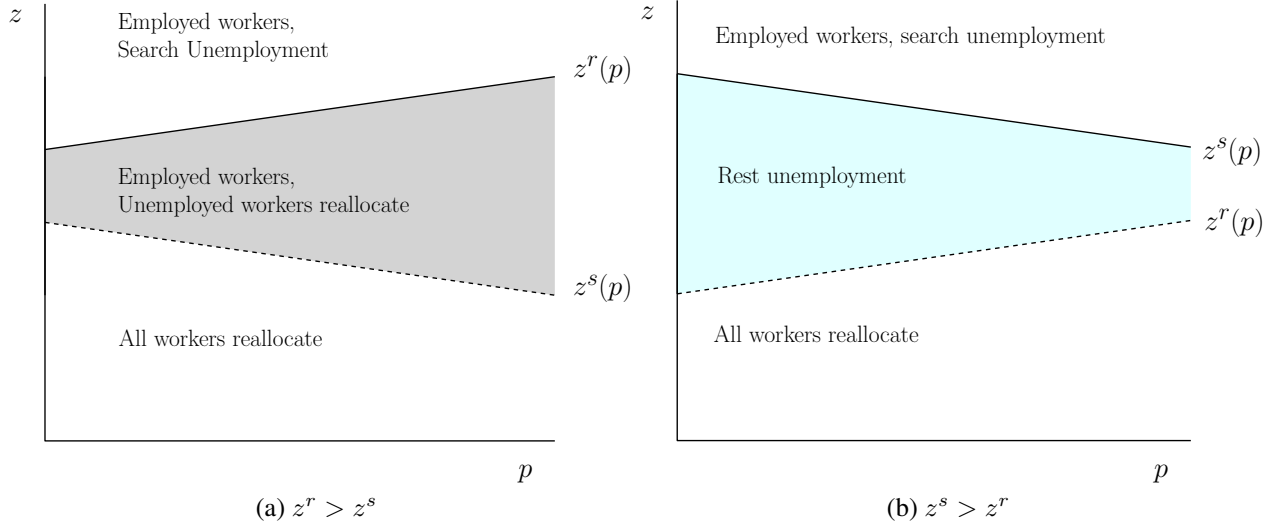

Figure 3: Relative positions of the reservation productivities

5.1 Reservation Cutoffs for Separations and Reallocation

Lemma 1 (Separation cutoff function $z^s(p)$). *If $\delta + \lambda(\theta(p, z)) < 1$, for all p, z in equilibrium, there exists a unique cutoff function $z^s(p)$ that depends only on p , such that $d(p, z) = \sigma(p, z) = 1$ if and only if $z < z^s(p)$, and $d(p, z) = \sigma(p, z) = 0$ otherwise.*

The separation cutoff function z^s is related to the one found in Mortensen and Pissarides (1994) because it characterises endogenous separations. However, in our setup z refers to the worker's idiosyncratic productivity in an occupation, rather than to a match-specific productivity with a firm. This difference implies that when the worker becomes unemployed, his z -productivity is not lost or is reset when re-entering employment in the same occupation. Instead, the worker's z -productivity continues to shape his outcomes in unemployment as well. It is only when the worker changes occupation that he resets his z -productivity.

A worker decides to reallocate when the expected value of staying unemployed in his current occupation falls below the expected value of reallocation. Assumption 1 guarantees that $W^U(p, z)$ from equation (1) is increasing in z , and by Lemma 1 so is $\max\{\lambda(\theta(p, z^r(p)))(W^E(p, z^r(p)) - W^U(p, z^r(p))), 0\}$. Given that $R(p)$ is constant in z , there exists a **reallocation cutoff function** $z^r(p)$ such that workers reallocate if and only if $z < z^r(p)$ for every p , where $z^r(p)$ satisfies

$$\begin{aligned}
 & W^U(p, z^r(p)) + \max\{\lambda(\theta(p, z^r(p)))(W^E(p, z^r(p)) - W^U(p, z^r(p))), 0\} \\
 & = -c + \int_{\underline{z}}^{\bar{z}} W^U(p, \tilde{z}) dF(\tilde{z}) \stackrel{def}{=} R(p).
 \end{aligned} \tag{8}$$

The relative position and the slopes of z^r and z^s are crucial for agents' behavior and aggregate outcomes in our model. Figure 3a, for example, shows the case in which $z^r > z^s$ for all p . In this case, having a job makes a crucial difference on whether a worker stays or leaves his current occupation. In particular, when $z \in [z^s, z^r)$, the match surplus generated by the worker-firm pair

is enough to keep the employed worker attached to his occupation. For an unemployed worker with a z in the same interval, however, the probability of finding a job is sufficiently small to make reallocation the more attractive option, even though this worker could generate a positive match surplus if he were to become employed. For values of $z < z^s$, all workers reallocate. For values of $z \geq z^r$, firms post vacancies and workers remain in their occupations, flowing between unemployment and employment over time as in the canonical DMP model.

Figure 3b shows the opposite case, in which $z^s > z^r$. In this case, workers who quit into unemployment, at least initially, do not reallocate, while firms do not create vacancies in labor markets associated with values of $z < z^s$. Workers with z -productivities between z^s and z^r are **rest unemployed**: they face a very low – in the model, starkly, zero – contemporaneous job finding probability, but still choose to remain attached to their occupations. The stochastic nature of the z -productivity process, however, implies that these workers can face a positive expected job finding probability for the following period.¹⁴ Only after the worker’s z -productivity has declined further, below z^r , a rest unemployed worker reallocates. Otherwise, the worker stays in his occupation for possible improvements of his z -productivity. For values of $z \geq z^s$, the associated labor markets function as in the canonical DMP model.

An unemployed worker is considered **search unemployed** when this worker is in a labor market in which firms are currently posting vacancies. A worker is considered **reallocation unemployed** only during the time he is trying to find another occupation in which his labor market conditions are sufficiently good; i.e. obtain a $z > z^r$. Once he finds an occupation where his z -productivity realization lies above z^r , he becomes search or rest unemployed, depending on whether $z > z^s$ and on the relative position of z^s and z^r . An occupational mover is a worker who left his old occupation, went through a spell of unemployment (which could encompass all three types of unemployment) and has found a job in a different occupation. The distinction between reallocation unemployed and occupational movers is made to be consistent with the way we measured occupational mobility in Section 2.

5.2 The Occurrence of Rest Unemployment

The key decision that an unemployed worker makes, is whether to remain in his occupation, *waiting* to see if his z -productivity improves, or to reallocate to another occupation, drawing a new z -productivity immediately. Rest unemployment arises when the value of waiting is sufficiently large. This decision is similar to an ‘optimal scrapping’ problem under uncertainty, where the

¹⁴Rest unemployed workers should be thought of as workers displaying the search activities that the BLS requires to consider a worker as unemployed (e.g. contacting employment agencies, employment centres, checking union and professional registers, or sending out resumes). After performing these activities, rest unemployed workers then could find out that there are little (or starkly, no) appropriate jobs available for them, and hence they will face a contemporaneous job finding probability of zero. As shown below, the volatility in the z -productivity process generating rest unemployment in our model can also rationalize that these workers keep paying attention to the conditions on their specific labor markets, as they could improve, potentially within a short span of time. This is in contrast to settings with permanent worker heterogeneity, where some unemployed could predict that *aggregate* productivity needs to recover substantially, which in itself might take some time, before they become employable again.

option value of waiting typically plays an important role in determining whether and when a firm should upgrade technologies or close plants. As emphasised by, for example, Dixit and Pindyck (1994), in these type of problems the option value of waiting becomes meaningful (i) when there is enough uncertainty about the net returns of the investment and (ii) when the investment and/or its cost is at least partially irreversible. In our model, the degree of uncertainty on the net returns of reallocation crucially depend on the properties of the z -productivity process, while reallocation frictions generate irreversible costs: a worker sinks in reallocation cost c and loses a period of time, plus he loses his occupational human capital.¹⁵ The region $[z^r, z^s]$, in which unemployed workers prefer to wait in their occupations, corresponds generally to the real-options literature’s ‘region of inaction’, in which agents choose to hold off investment (see, for example, Stokey, 2008, and Bloom, 2009).

In addition to the option value associated with waiting in unemployment in one’s occupation, the presence of search frictions in the model also implies that there is an option value associated with waiting in employment in an existing match. Workers will remain employed at a lower output value that they would in the absence of search frictions, because of potential future improvements in their z -productivities, in the face of irreversible match destruction. This drives the separation cutoff z^s down, working against rest unemployment. We now explore under what conditions the model creates predominantly labor hoarding in employment matches (as in Mortensen and Pissarides, 1994), leading to no rest unemployment (Figure 3a); or inside occupations in unemployment (as in Alvarez and Shimer, 2011a), creating rest unemployment (Figure 3b).¹⁶

To do so, we analyse how the value of waiting in unemployment and in employment changes with c , b and the persistence of the z -productivity, and how these changes determine the relative position of z^r and z^s . The simplest setting that captures a motive for waiting is one in which the z -productivity is redrawn randomly with probability $0 < (1 - \gamma) < 1$ each period from cdf $F(z)$ and p is held constant. Time-variation in z is essential here because a worker can decide to stay unemployed in his occupation, even though there are no jobs currently available for him, when there is a high enough probability that his z -productivity will become sufficiently high in the future. All other features of the model remain the same, with the exception of no human capital accumulation, which we discuss later. In Appendix B we formulate the value functions for this stationary environment.

In this setting, the expected value of an unemployed worker with productivity z , measured at

¹⁵These features are what makes occupational reallocation in our model different from, for example, investment in general training, as in the Ben-Porath model. In that case, investment in general human capital is additive to the existing stock of human capital and is repeated every period. These aspects make general training to a large extent fungible across periods (and hence effectively reversible), reducing the importance of the option value of waiting in a worker’s decision to undertake training.

¹⁶The presence of search frictions is in contrast with models that analyse rest unemployment assuming competitive labor markets, like Alvarez and Shimer (2011a). In these models, workers do not face a value of waiting in employment as a worker becomes employed if and only if his contemporaneous productivity is higher than the contemporaneous flow benefit when not working. In Mortensen and Pissarides (1994), there is no value of waiting in unemployment, as all unemployed workers face exactly the same conditions, which depend only on aggregate productivity.

the production stage, is given by

$$W^U(p, z) = \gamma \left(b + \beta \max \left\{ R(p), W^U(p, z) + \max \{ \lambda(\theta(p, z))(1 - \eta)(M(p, z) - W^U(p, z)), 0 \} \right\} \right) + (1 - \gamma) \mathbb{E}_z[W^U(p, z)]. \quad (9)$$

Equation (9) shows that there are two ways in which an unemployed worker with a z -productivity below z^s can return to production. *Passively*, he can wait until his z -productivity increases exogenously. Or, *actively*, by paying c and sampling a new z in a different occupation. In the former case, $\max\{.\} = W^U(p, z^s(p))$, while in the latter case $\max\{.\} = R(p)$. The difference $W^U(p, z^s(p)) - R(p)$, then captures the relative gain of passively waiting for one period over actively sampling a new z immediately. If $W^U(p, z^s(p)) \geq R(p)$, then $z^s \geq z^r$ and there is rest unemployment. If $R(p) > W^U(p, z^s(p))$, then $z^r > z^s$, and endogenously separated workers reallocate immediately.

Changing c , b , or γ will affect the relative gains of waiting, in employment and in unemployment. In the following lemma we derive the direction of the change in $W^U(p, z^s(p)) - R(p)$, where we take fully into account the feedback effect of changes in c , b , or γ on the match surplus $M(p, z) - W^U(p, z)$ that arises because of search frictions.

Lemma 2. *Changes in c , b or γ imply*

$$\frac{d(W^U(p, z^s(p)) - R(p))}{dc} > 0, \frac{d(W^U(p, z^s(p)) - R(p))}{db} > 0, \frac{d(W^U(p, z^s(p)) - R(p))}{d\gamma} < 0.$$

It is intuitive that raising the cost of reallocation directly increases the relative gains of waiting. An increase in c , however, also leads to a larger match surplus because it reduces $W^U(p, z)$, making employed workers less likely to separate and hence reducing rest unemployment. The lemma shows that, overall, the first effect dominates. A rise in b lowers the effective cost of waiting, while at the same time decreasing the match surplus by increasing $W^U(p, z)$, pushing towards more rest unemployment. An increase in γ , decreases the gains of waiting by decreasing the probability of experiencing a z -shock without paying c and increasing the value of sampling a good z -productivity. In Appendix B, we further prove that an increase in $W^U(p, z^s(p)) - R(p)$ leads to an increase in $z^s(p) - z^r(p)$ when $z^r(p)$ and $z^s(p)$ are interior: for a sufficiently large c , b and γ , rest unemployment arises.

Rest Unemployment and Occupational Human Capital Occupational human capital accumulation makes a worker more productive in his current occupation. This implies that workers are willing to stay longer unemployed in their occupations because, for a given z , they can find jobs faster and receive higher wages. At the same time, a higher x makes the employed worker less likely to quit into unemployment, generating a force against rest unemployment. Taken together, however, the first effect dominates as the next result shows.

Lemma 3. *Consider a setting where p is fixed, z redrawn with probability $(1 - \gamma)$, and production*

is given by $y = pxz$. Consider an unexpected, one-time, permanent increase in occupation-specific human capital, x , from $x = 1$. Then

$$\frac{d(W^U(p, z^s(p, x), x) - R(p))}{dx} > 0 \quad (10)$$

This result implies that the difference $z^s(p, x) - z^r(p, x)$ becomes larger when human capital increases and $z^r(p, x)$ and $z^s(p, x)$ are interior. Thus, more occupational human capital leads to rest unemployment.

5.3 The Cyclicity of Reallocations and Separations

In Section 2 we documented that occupational mobility through unemployment is procyclical, while it is well established that job separations are countercyclical (see also Table 5 below). In the model, the cyclicity of workers' reallocation and job separation decisions is characterised by the slopes of the cutoff functions z^r and z^s with respect to p . As depicted in Figure 3, reallocations are procyclical and job separations countercyclical when $dz^r/dp > 0$ and $dz^s/dp < 0$, respectively. We now explore the conditions under which such slopes arise endogenously in our model. In particular, we show that when search and rest unemployment coexist, reallocations tend to be procyclical and job separations countercyclical.

Reallocations We start by investigating the impact of rest unemployment on the slope of z^r . Using equation (8) and noting that $R(p) - W^U(p, z^r(p)) = 0$, we obtain

$$\frac{dz^r}{dp} = \frac{\int_{z^r}^{\bar{z}} \left(\frac{\partial W^U(p, z)}{\partial p} - \frac{\partial W^U(p, z^r)}{\partial p} \right) dF(z) - \frac{\partial}{\partial p} \left(\lambda(\theta(p, z^r))(W^E(p, z^r) - W^U(p, z^r)) \right)}{\frac{\partial W^U(p, z^r)}{\partial p} + \frac{\partial}{\partial z^r} \left(\lambda(\theta(p, z^r))(W^E(p, z^r) - W^U(p, z^r)) \right)}. \quad (11)$$

Since reallocating workers must sit out one period unemployed, the term $\lambda(\theta(p, z^r))(W^E(p, z^r) - W^U(p, z^r))$ captures the expected loss associated with the time cost of reallocation: by not reallocating, the worker could match with vacancies this period. When $z^r > z^s$, $\lambda(\theta(p, z^r))(W^E(p, z^r) - W^U(p, z^r)) > 0$ and is increasing in p and z^r . Therefore, an increase in p in this case, increases the loss associated with the time cost of reallocation and decreases dz^r/dp . However, with rest unemployment ($z^s > z^r$), $\lambda(\theta(p, z^r))(W^E(p, z^r) - W^U(p, z^r)) = 0$ and this effect disappears. This follows as rest unemployed workers have a contemporaneous job finding rate of zero and hence by reallocating, the worker does not lose out on the possibility of matching this period. In this case, the cyclicity of reallocation purely depends on the remaining terms, in particular $\int_{z^r}^{\bar{z}} \left(\frac{\partial W^U(p, z)}{\partial p} - \frac{\partial W^U(p, z^r)}{\partial p} \right) dF(z)$. Thus, rest unemployment adds a procyclical force to reallocations.

Now consider the impact of search frictions on the slope of z^r . We focus on the more general case of $z^r > z^s$, which includes the additional countercyclical force discussed above. To gain analytical tractability we use the simplified setting of Section 5.2, where we set $\gamma = 1$ such that workers' z -productivities are permanent. This allows us to link wages and labor tightness to $y(p, z)$

in closed form. We then analyse the effects of a one-time, unexpected, and permanent change in p on z^r .¹⁷ To isolate the role of search frictions, we compare this case with one without search frictions in which workers (who are not currently reallocating) can match instantaneously with firms and are paid $y(p, z)$. In both cases we keep in place the same reallocation frictions. Let z_c^r denote the reallocation cutoff in the case without search frictions. The details of both cases, including the corresponding value functions, can be found in Appendix B.

Lemma 4. *Consider a one-time, unexpected, permanent increase in p . With search frictions the cyclical response of reallocations is given by*

$$\frac{dz^r}{dp} = \frac{\beta \int_{z^r}^{\bar{z}} \left(\left(\frac{C_s(p, z)}{C_s(p, z^r)} \right) y_p(p, z) - y_p(p, z^r) \right) dF(z) - (1 - \beta) y_p(p, z^r)}{(1 - \beta F(z^r)) y_z(p, z^r)}, \quad (12)$$

where $y_i(p, z) = \partial y(p, z) / \partial i$ for $i = p, z$ and $C_s(p, z) = \frac{\beta \lambda(\theta(p, z))}{(1 - \beta)(1 - \beta + \beta \lambda(\theta(p, z)))}$. Without search frictions the cyclical response is given by

$$\frac{dz_c^r}{dp} = \frac{\beta \int_{z_c^r}^{\bar{z}} (y_p(p, z) - y_p(p, z_c^r)) dF(z) - (1 - \beta) y_p(p, z_c^r)}{(1 - \beta F(z_c^r)) y_z(p, z_c^r)}. \quad (13)$$

The first term in the numerator of (12) and (13) relates to $\int_{z^r}^{\bar{z}} \left(\frac{\partial W^U(p, z)}{\partial p} - \frac{\partial W^U(p, z^r)}{\partial p} \right) dF(z)$ in equation (11), while the second term captures the opportunity cost of the reallocation time. The proof of Lemma 4 shows $C_s(p, z) / C_s(p, z^r)$ is increasing in z and $\frac{dz^r}{dp} > \frac{dz_c^r}{dp}$ at $z^r = z_c^r$. Thus, the presence of search frictions also adds procyclicality to reallocations. Search frictions lead to a steeper reallocation cutoff function because, in this case, an increase in p increases $W^U(p, z)$ through *both* the wage and the job finding probability. In contrast, an increase in p in the frictionless case only affects $W^U(p, z)$ through wages (with a proportionally smaller effect on $w - b$), as workers always find jobs with probability one. The fact that $C_s(p, z) / C_s(p, z^r)$ is increasing in z for $z > z^r$, reflects that the impact of output, $y(p, z)$, on $W^U(p, z)$ is increasing in z . Indeed, from the proof of Lemma 4 one obtains $\frac{\partial W^U(p, z)}{\partial p} / \frac{\partial W^U(p, z^r)}{\partial p} = \frac{C_s(p, z) y_p(p, z)}{C_s(p, z^r) y_p(p, z^r)} > \frac{y_p(p, z)}{y_p(p, z^r)}$ for $z > z^r$.¹⁸

In addition, (12) and (13) show that the cyclicity of reallocations in either case depends on the production function $y(p, z)$, in particular on the sign of $y_p(p, z) - y_p(p, z^r)$ for $z > z^r$. In the proof of Lemma 4 we show that with search frictions, reallocations will already be procyclical when the

¹⁷This approach follows Shimer (2005), Mortensen and Nagypal (2007a), and Hagedorn and Manovskii (2008). Since the equilibrium value and policy functions only depend on p and z , analysing the change in the expected value of unemployment and joint value of the match after a one-time productivity shock is equivalent to compare those values at the steady states associated with each productivity level. This is because in our model the value and policy functions jump immediately to their steady state level, while the distribution of unemployed and employed over occupations takes time to adjust.

¹⁸One can get further intuition by considering the planners' problem. The envelope condition implies that the planner, at the optimum allocation, does not need to change labor market tightness at each z for an infinitesimal change in p to still obtain the maximum net increase in expected output. At a given z , this means that an increase of dp creates $dW^U(p, z) = \frac{\beta \lambda(\theta(p, z))}{(1 - \beta)(1 - \beta + \beta \lambda(\theta(p, z)))} y_p(p, z) dp = C_s(p, z) y_p(p, z) dp$ in additional life-time expected discounted output for the planner. Since our economy is constrained efficient, the change in p also creates the same lifetime expected discounted income for an unemployed worker with such z .

production function is modular and z^r is sufficiently close to z^s . This follows because the opportunity cost of reallocation becomes smaller as z^r approaches z^s from above. With rest unemployment this opportunity cost is zero. If z^r is substantially above z^s , we will need sufficient complementarities between p and z in the production function to obtain procyclical reallocations. Without search frictions, in contrast, a supermodular production function is only a necessary condition to generate procyclical reallocations.

Job Separations The main aspect of having endogenous separations and reallocations is that the two can potentially interact. In particular, if $z^r > z^s$, workers separate endogenously to reallocate and this could lead to reallocations and separations having the same cyclical behavior. For example, in the setting of Lemma 4, we show (in the Supplementary Appendix) that dz^s/dp depends directly on dz^r/dp . Namely,

$$\frac{dz^s(p)}{dp} = -\frac{y_p(p, z^s(p))}{y_z(p, z^s(p))} + \frac{\beta\lambda(\theta(p, z^r(p)))}{1 - \beta(1 - \delta) + \beta\lambda(\theta(p, z^r(p)))} \frac{y_p(p, z^r(p))}{y_z(p, z^s(p))} \left(1 + \frac{y_z(p, z^r(p))}{y_p(p, z^r(p))} \frac{dz^r(p)}{dp} \right).$$

The second term makes explicit the interaction between separation and reallocation decisions when there is no rest unemployment. It captures the change in the gains of reallocation, $dR(p)/dp$, and shows that separations and reallocations can have the same cyclical behavior. When instead $z^s > z^r$, workers separate into rest unemployment. In this case, $R(p)$ has a smaller impact on the value of unemployment at the moment of separation. This is because a reallocation would only occur further in the future, and then only if a worker's z -productivity would deteriorate below z^r . Thus, rest unemployment weakens any feedback of procyclical reallocation onto separations. Indeed, by setting $\lambda(\cdot) = 0$ in the previous expression we get that separations are always countercyclical.

6 Quantitative Analysis

We now analyse the quantitative implications of our theory. For this purpose we draw from the evidence presented in Section 2 to calibrate our model. The calibration highlights the importance of rest unemployment in enabling the model to be consistent with this evidence. Further, the calibration also highlights the importance of rest unemployment as the main driving force behind the cyclical behavior of the aggregate unemployment rate and the unemployment duration distribution.

6.1 Calibration Strategy

We set the model's period to a week and the discount factor β to match a yearly real interest rate of 4%.¹⁹ The production function is multiplicative and given by $y = pxz$, chosen to keep close to

¹⁹To keep the size of the simulation manageable we let workers exit the labor force after an average of 40 years. Unemployed workers with the lowest occupational human capital level replace those that leave the labor force and are allocated randomly across occupations and z -productivities. This feature implies that $\beta = (1 - d)/(1 + r)$, where the exit probability, d , is chosen to match an average working life of 40 years and r is chosen so that β matches a yearly real interest rate of 4%.

a ‘Mincerian’ formulation. We set the number of major occupations $O = 18$.²⁰ The evolution of a worker’s idiosyncratic productivity within an occupation, z_t , is modelled as an AR(1) process with autoregressive parameter ρ_z and dispersion parameter σ_z . Workers’ occupational human capital is parametrized by a three-level process, $h = 1, 2, 3$. We normalize $x_1 = 1$ and set $\chi(x_{h+1}|x_h)$ such that the next level is stochastically acquired after five years on average. Aggregate productivity, p_t , follows an AR(1) process with persistence and dispersion parameters given by ρ_p and σ_p . We add a normalisation parameter z_{norm} that moves the distribution of z -productivities downwards such that the measured total productivity of our economy averages one.

This parametrisation yields a set $\Theta = \{\delta, k, b, \rho_p, \sigma_p, \eta, z_{norm}, \rho_z, \sigma_z, c, x_2, x_3\}$, with 12 parameters, to estimate. To do so, we minimise the sum of squared distances between a set of simulated moments from the model and their counterparts in the data, using the identity matrix as weighting matrix.

Table 3: Targeted Moments. Data and Model Comparison

Moments	Data	Model	Moments	Data	Model
ave. job finding rate	0.269	0.258	Unemployment Survival		
matching function: $\hat{\eta}$	0.500	0.512	≤ 4 months	0.373	0.395
Aggregate Productivity			≤ 8 months	0.130	0.133
y (normalised)	1	0.999	≤ 12 months	0.055	0.047
ρ_y	0.691	0.689	Occ Mobility by Unemployment Duration		
σ_y	0.009	0.009	1 month	0.519	0.405
Age-groups			3 months	0.556	0.536
$urate_y$	0.067	0.074	6 months	0.582	0.584
$urate_p$	0.040	0.043	9 months	0.614	0.625
$\ln(OccMob_y/OccMob_p)$	0.134	0.146	12 months	0.610	0.640
Returns to Occupational Exp.			Mobility in Subsequent Unemp. Spells		
5 years	0.154	0.140	Occ Stay after Occ Stay	0.621	0.610
10 years	0.232	0.242	Employed with Us-spell within 3 years		
			proportion of empl.	0.1441	0.167

Targeted Moments We target 20 moments based on the aggregate long-run behavior of the economy. These are described in Table 3. The targeted moments are compared with the corresponding moments from model simulations, where we generate ‘pseudo-SIPP panels’ for consistent measurement.²¹ The first six parameters in Θ are shared with the standard DMP model and are informed by similar moments.²² For example, the exogenous separation probability, δ , and vacancy cost, k , are informed by the average aggregate unemployment and job finding rates obtained from

²⁰The number of occupations we chose is the average number of occupations across the three versions of the SOC we used in Section 2.

²¹Specifically, we consider many 3.5-4 year panels of individual worker data generated from a long simulated time series. The model values reported in Table 3 are the averages over up to 2000 such panels.

²²Note, however, that in our model the mapping between $\{\delta, k, b, \rho_p, \sigma_p, \eta\}$ and the corresponding data moments is affected by endogenous job separations, rest and reallocation unemployment, and the endogenous shift of the distribution of workers’ occupational productivities.

the SIPP, while the persistence and standard deviation of the aggregate productivity process, ρ_p and σ_p , are informed by the series of output per worker obtained from the BLS. The elasticity of the matching function on each labor market, η , relates through aggregation to the empirical elasticity of the aggregate job finding rate, $\hat{\eta}$. We take the latter to be 0.5, in the range of Petrongolo and Pissarides (2001). Further, we use several age-related moments to inform us about b , where the link between these moments and b arises due to occupational human capital accumulation. The returns to the latter, x_2 and x_3 , are closely linked to the measured returns to occupational experience. Given it is difficult to estimate returns to occupational experience accurately with the SIPP due to the relative short nature of its panels, we use the OLS estimates for 1-digit occupations reported in Kambourov and Manovskii (2009b).²³

The crucial parameters in our calibration are ρ_z , σ_z and c . These are further informed by the remaining set of 10 moments, most of them drawn from the evidence presented in Section 2. In particular, the relationship between unemployment duration and occupational mobility, as described in Figure 1, informs us about ρ_z , σ_z and c . The *slope* of this relationship at long durations informs us about ρ_z . Intuitively, as the unemployment durations increase, workers are more likely to face labor market conditions close to the reallocation cutoff z^r . The parameter ρ_z determines the strength with which the mean reversion of the z -process pulls these workers across (or away from) the reallocation cutoff. This implies a more positive (resp. negative) slope of the reallocation rate at long unemployment durations. The *level* of this relationship at long durations, on the other hand, inform us about σ_z . In this case, larger innovations in the z -process make it more likely that long-term unemployed workers fall below the z^r cutoff. The extent of duration dependence, captured in the 3 unemployment survival moments, also informs us about ρ_z and σ_z .²⁴ The overall level of occupational mobility at *all* unemployment durations contains information on c , taking as given ρ_z and σ_z . This follows as the parameters ρ_z and σ_z completely determine the transitions of workers' z -productivities within an occupation. In combination with cutoffs z^r and z^s , these transitions directly imply an overall amount of occupational mobility of unemployment workers. From Lemma 2, we know that, given ρ_z and σ_z , the relative position of these cutoffs depend on c in a monotonic way, allowing us to infer c .

We also target the difference between prime-aged and young workers' occupational mobility rates, $\ln(OccMob_y/OccMob_p)$. This moment contains further information about σ_z . When workers' z -productivities are more dispersed, human capital differences in output are less important than z -productivity differences. In turn, this brings the job separation and occupational mobility

²³We compute the aggregate unemployment rates from the SIPP by dividing the stock of unemployed workers in a given period by the size of the labor force in the same period. We compute the series of output per worker for the 1986-2011 period to maintain consistency with the sample period used for the SIPP. See the Supplementary Appendix for further details. To obtain the model's counterpart of $\hat{\eta}$, we estimate on simulated data a reduce form *aggregate* matching function by OLS using a Cobb-Douglas specification. In the case of occupational human capital, we use the OLS estimates because occupation selection occurs both in the model and in the data. In our model selection arises as measured returns are a result of two opposing forces: human capital acquisition and z -productivity mean reversion.

²⁴We use the cumulative survival rates at intervals of 4 months to reduce the seam bias found in the SIPP.

patterns of young and prime-aged workers closer together. We also use the repeat mobility patterns documented in Section 2, to capture the persistence of occupational attachment among the selected group of occupational stayers. Note that this moment is the complement of the reported 38% of occupational stayers that after a subsequent unemployment spell changed occupation. This moment further informs us about the persistence of the z -process, as captured by ρ_z, σ_z , and the role of occupational human capital in creating additional attachment to occupations. Finally, we add the empirical proportion of employed workers who will experience at least one unemployment spell during the subsequent three years. Given a fixed number of spells, this moment shows the extent of state dependence in unemployment and informs us about the importance of endogenous separations and rest unemployment.

Table 4: Calibrated Parameters

δ	k	b	c	η	ρ_p	σ_p	ρ_z	σ_z	z_{corr}	x_2	x_3
0.0002	3.582	0.738	14.54	0.048	0.981	0.003	0.9992	0.0078	0.513	1.104	1.487

Parameters Table 4 reports the resulting parameter values implied by the calibration. The value of b represents 74% of total average output, y , in line with Hall and Milgrom (2008), though estimated using different information. The estimated value of c and the sampling process, imply that upon starting a new job in a new occupation, a worker has paid on average a reallocation cost of about 10 months of output. This suggests that reallocation frictions across major occupations are important, and add to the significant loss in occupational human capital when changing occupation.²⁵ Note that the parameter linked to the actual returns to occupational experience at 10 years, x_3 , is higher than the OLS returns. This occurs because the best z -productivities mean revert over time, and at the same time, experienced workers find it still profitable to work at worse z -productivities. In turn, this dampens the *composite* xz -productivity on which measurement of the returns to occupational experience are based.

Our calibration implies that the process driving workers’ idiosyncratic productivities within an occupation is, in relative terms (i.e. in the log), more persistent than the aggregate shock process

²⁵Our data suggests that both the reallocation cost c and the loss of occupational human capital when reallocating, should be incorporated in our estimation. This is because we find a substantial proportion of occupational stayers (1) among young workers, which are typically associated with low levels of occupational human capital, and (2) we find substantial occupational staying (around 45%) among those who moved occupations but subsequently have become unemployed again. Since this occurs within the duration of a SIPP panel, the occupational tenure that these workers have accumulated is low, yet they also display significant occupational attachment. The high value of c reported in Table 4 is consistent with these features of the data as well as with the large proportion of unemployed workers that change occupation, documented in Table 1. In our theory, c captures the costs associated of gathering information and learning how the labor market operates once in the new occupation. However, given that in the data occupational changes are typically accompanied by changes in industries (based in our own calculations) and, to a lesser extent, by geographical location (see Papageorgiou, 2013), the estimated value of c should also be capturing the moving costs associated with these changes. Indeed, Alvarez and Shimer (2011a) find large reallocation costs across industries, while Kennan and Walker (2011) and Papageorgiou (2013) find large reallocation costs across geographical locations.

driving the business cycle. However, its larger variance implies there is much more dispersion across workers' z -productivities than there is across values of p . The component of exogenous separations, δ , is small, which implies that most separations in the calibration are endogenous. Also note that the elasticity of the matching function within each labor market, η , is small, given employed workers a high bargaining power. Note that this value is consistent with an elasticity $\hat{\eta}$ of 0.5, when we aggregate across labor markets and occupations.²⁶

6.2 Fit of the Model

Table 3 reports the fit between the simulated and the targeted moments. The simulated moments are computed by aggregating across all labor markets and occupations. The model appears to fit the data remarkably well, given the extent of over-identification. With only three parameters ρ_z , σ_z and c , our model is able to reproduce very closely the main features that characterise gross reallocation through unemployment, outlined in Section 2. In addition, the model captures the duration dependence of unemployment very well, matching the empirical amount of long-term unemployment and at the same time producing a large amount of occupational mobility.²⁷ All this is achieved with a large proportion of occupational stayers among the unemployed at all durations. A too-quick conjecture that substantial occupational mobility is inconsistent with long-term unemployment is wrong.²⁸

The model is also able to match the proportion of employed workers that become unemployed within a three-year window. This implies that the model can produce a concentration of unemployment incidence in line with the data. Furthermore, the proportion of those unemployed that were occupational stayer after ending their last two unemployment spells is also closely matched. As we will now argue, the prevalence of rest unemployment is the main reason why the model is able to capture these moments very well.

²⁶The existence of rest unemployment, see Section 6.3, generates the difference between $\hat{\eta}$ and η . In downturns, for example, more unemployed get absorbed into rest unemployment. As a result, the aggregate tightness and job finding rate drop significantly. This implies that in labor markets close to z^s , the job finding rates need not change by so much to still achieve an aggregate elasticity of 0.5, which contributes to a much lower elasticity within these labor markets.

²⁷The relative low proportion of occupational movers at one month of unemployment in the calibration is mainly due to three aspects of the model. (i) A uniform time cost per sample of a z -productivity, suppresses very early outflows into employment for occupational movers. (ii) Exogenous and immediate separations of workers with high z -productivities, lead to a set of occupational stayers quickly moving in and out of unemployment. (iii) Since the endogenous separation productivity cutoff is also a vacancy posting cutoff, this also induces sometimes too quick rehiring upon a small positive z -shock. These forces over-emphasize occupational staying and de-emphasize occupational moving at the lowest unemployment spell lengths, but, importantly, the aforementioned effects diminish quickly with unemployment spell duration.

²⁸In terms of the implied job finding probabilities by unemployment duration, the model also generates a good fit with the data. The job finding probabilities at 4, 8 and 12 months are (0.25, 0.25), (0.23, 0.22) and (0.23, 0.18), where the first number of each pair refers to the model and the second to the data. Only considering occupational movers we have (0.20, 0.24), (0.22, 0.21) and (0.21, 0.19); while for occupational stayers the corresponding numbers are (0.29, 0.28), (0.25, 0.23) and (0.24, 0.18).

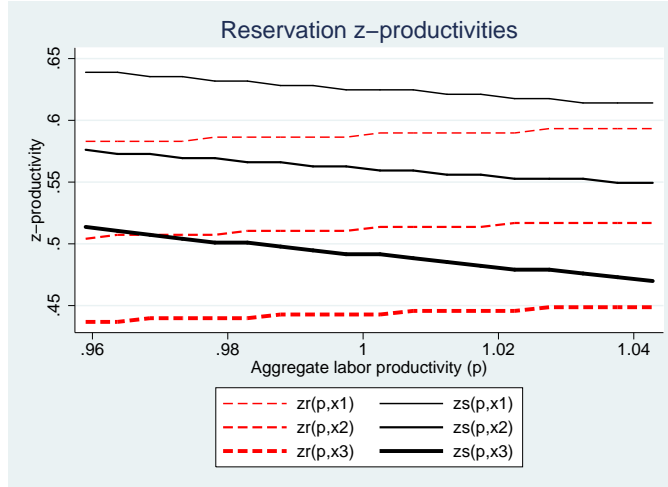

Figure 4: Reservation functions by occupational human capital

6.3 Rest Unemployment

In Lemmas 2 and 3 we have shown, in a simplified setting, that the relative positions of z^s and z^r depend on the properties of the z -productivity process, c , b and x_h . Figure 4 depicts the cutoff functions generated by the calibrated model for each occupation, where $z^s(p, x_h)$ and $z^r(p, x_h)$ denote the separation and reallocation cutoffs for each p and x_h . It shows that the estimated parameter values yield $z^s > z^r$ for all p and $h = 1, 2, 3$. That is, unemployed workers with z -productivities above z^s are search unemployed. Those workers with $z \in [z^r, z^s]$ are rest unemployed, while workers with $z < z^r$ reallocate. We find that rest unemployment is by far the most important type of unemployment. On average, rest unemployment constitutes 68.6% of aggregate unemployment, while search and reallocation unemployment account for 20.6% and 10.8%, respectively.²⁹

In the calibration, as p and z evolve, workers transit between search, rest and reallocation unemployment. Given the values for b and x_h , the values of c , ρ_z and σ_z mainly determine the distance between $z^s(p, x_h)$ and $z^r(p, x_h)$, the amount of workers that are search, rest and reallocation unemployed and the time it takes workers to transit between these types of unemployment. As discussed earlier, these parameters are informed by evidence on the extent of occupational mobility, duration dependence and its relationship with occupational mobility, repeat mobility and the degree of concentration of unemployment spells among a subset of workers. Rest unemployment is prominent in our calibration because it can reconcile all of these moments at the same time.³⁰

²⁹The relative sizes of the different types of unemployment are obtained by computing, for each p , x_h and o , the number of unemployed workers with z -productivities above the separation cutoffs, in between the separation and reallocation cutoffs, and below the reallocation cutoffs. As mentioned in Section 5.1, the extent of reallocation unemployment must not be confused with the extent of occupational mobility reported in Section 2. To construct occupational mobility measures in the simulations, we follow the same procedure as we did with the SIPP; i.e. we computed the number of workers that have lost their jobs, went through an unemployment spell and found a job in a new occupation.

³⁰Alvarez and Shimer (2011a) also show that rest unemployment explains a large proportion of aggregate unemployment. However, our inference approach differs from theirs. They use wage data to evaluate the relative importance of rest unemployment. Using wage data is useful for their estimation as their model generates a tight link between wage dynamics at an industry level and reallocation unemployment (search unemployment in their terminology). Here

In particular, suppose that $z^r > z^s$ such that no workers are rest unemployed as depicted in Figure 3a. In this case, the employed would have z -productivities in the range $[z^s, \bar{z}]$. Those employed workers with z -productivities below z^r would then face a high risk of a job separation and an immediate reallocation. Once the reallocation process ends, these workers would have z -productivities above z^r , facing a strictly lower probability of a future job separation. Moreover, those workers who stayed in their occupations after a spell of unemployment, would also have a low probability of changing occupations after a subsequent unemployment spell. This is because, with $z^r > z^s$, these workers would have z -productivities in the range $[z^r, \bar{z}]$. These features go against the extent of unemployment incidence among employed workers and the repeat mobility patterns documented in Table 3. In contrast, with $z^s > z^r$ and prominent endogenous job separations, as in the calibration, employed workers close to z^s face a high risk of separating. Upon becoming re-employed in the same occupation, these workers would still be close to z^s , facing once again a high job separation probability. Moreover, occupational movers are distributed over the entire range of z -productivities above z^s , facing a similar unemployment risk and subsequent reallocation behavior as occupational stayers, as suggested by the data.

A key aspect of our model is that the z -productivity process determines the transitions of an individual worker between employment, search, rest and reallocation unemployment. This is in contrast to Alvarez and Shimer (2011a), where the overall size of employment, rest and reallocation unemployment is determined, but not the individual transitions between these categories.³¹ This difference implies that our model is suitable to analyse the relationship between unemployment duration, occupational mobility and job finding probabilities as described earlier. We find that rest unemployment allows the model to capture the positive relationship between unemployment duration and occupational mobility and the negative relationship between unemployment duration and job finding rates.

To illustrate this in more detail, consider a set of newly rest unemployed workers with the same x_h in the calibrated model. Figure 5 depicts a set of possible histories for these workers given they separated endogenously at time t_0 . These workers will be in rest unemployment for as long as their z -productivity remains between z^r and z^s . Since the estimated z -process is close to a random

we want to estimate the properties of workers' z -productivity process. Our focus on gross mobility then implies that the average wage process at an occupational level will make it very difficult, if not impossible, to estimate the parameters of this process. Further, individual wage data captures additional volatility that is orthogonal to the z -productivity. Rather than extending our theory to capture this additional sources of volatility, we use those implications of our model that can be associated with transition and duration data to estimate the z -productivity process.

³¹In Alvarez and Shimer (2011a) this feature arises because, in equilibrium, workers on islands with rest unemployment are indifferent between work and rest; while on islands from which some workers are reallocating, workers are indifferent between work, rest and reallocation. In our model, workers typically are not indifferent between search, rest and reallocation. They will be indifferent between work, search and rest only if their z -productivities equal z^s . Similarly, workers will be indifferent between rest and reallocation if their z -productivities equal z^r . However, given z is continuous within an occupation these are zero probability events. Alvarez and Shimer (2011b) introduces union coverage, minimum wage levels and seniority-based hiring to the setting of Alvarez and Shimer (2011a). In this case, the indifferences mentioned above do not arise. Instead, the individual-specific seniority achieved within an industry becomes a determinant of individual unemployment durations and reallocation choices.

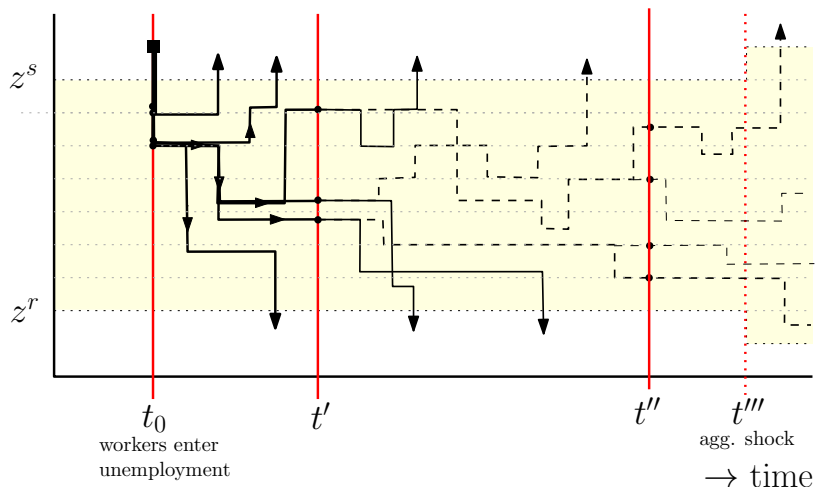

Figure 5: Labor Market histories

walk, these workers will be initially close to the z^s productivity cutoff. This implies that small positive shocks would already be sufficient to move these workers above z^s , where they will face a positive contemporaneous job finding rate; while only large negative shocks would take these workers below z^r soon after separation. Hence at short unemployment durations, workers face relatively high job finding rates and, if re-employed, they will be most likely occupational stayers.

Those workers who stayed unemployed for longer (in Figure 5 until t' , for example) will have typically experienced further negative idiosyncratic shocks. This implies that in the calibration the distribution of z -productivities is stochastically decreasing with unemployment durations. As a result, the likelihood of a reallocation increases with unemployment duration, while the job finding rate decreases with unemployment duration. The latter occurs because as unemployment duration increases workers become further removed from the nearest cutoff.

As workers become long-term unemployed, we find that the distribution of z -productivities becomes close to stationary between the separation and reallocation cutoffs (for example, consider t'' in Figure 5). At these unemployment durations, workers leave rest unemployment at a slower rate. The nearest cutoff is now typically further away: workers will then need a sequence of shocks pushing them in the same directions until they cross either the z^s or z^r cutoff. Nevertheless, we find that long-term unemployed workers remain attached to their old occupation for the time being as they still hold enough hope for a successful return to employment in it. This hope reflects that ultimately about 40% of workers return to employment in their previous occupation, even after a one-year spell.³²

As a result, rest unemployment also allows the model to be consistent with the fact that occu-

³²Shimer (2008) shows that a random walk process with a drift, in combination with an exogenous threshold, can match the duration dependence observed in the data. All unemployment spells start at this exogenous threshold, while above this threshold all workers are employed. This is somehow similar to our model since, in our calibration, the z -productivity process is close to a random walk and most of the unemployed are below the separation cutoff. However, in our model, there is a second threshold, as reallocation is another key determinant of unemployment outcomes. Furthermore, both separation and reallocation cutoffs are endogenous, and respond to business cycle conditions.

Table 5: Logged and HP-filtered Business Cycle Statistics. Data and Model

	Data: 1986-2011							Model						
	<i>u</i>	<i>v</i>	θ	<i>s</i>	<i>f</i>	<i>y</i>	<i>Cm</i>	<i>u</i>	<i>v</i>	θ	<i>s</i>	<i>f</i>	<i>y</i>	<i>Cm</i>
σ	0.13	0.11	0.23	0.13	0.10	0.01	0.03	0.15	0.08	0.21	0.10	0.13	0.01	0.06
ρ_{t-1}	0.97	0.93	0.94	0.83	0.93	0.69	0.85	0.74	0.25	0.64	0.06	0.55	0.69	0.81
Correlation Matrix														
<i>u</i>	1.00	-0.84	-0.96	0.67	-0.78	-0.52	-0.26	1.00	-0.61	-0.96	0.32	-0.80	-0.98	-0.77
<i>v</i>		1.00	0.95	-0.69	0.46	0.66	0.30		1.00	0.82	-0.38	0.67	0.68	0.6
θ			1.00	-0.72	0.47	0.63	0.30			1.00	-0.37	0.83	0.97	0.71
<i>s</i>				1.00	-0.67	-0.68	-0.32				1.00	-0.79	-0.39	-0.27
<i>f</i>					1.00	0.45	0.40					1.00	0.84	0.59
<i>y</i>						1.00	0.26						1.00	0.72

pational movers take longer to find jobs. This is because after separation into rest unemployment, occupational movers would typically have spent a longer time in rest unemployment than occupation stayers. This is in contrast to models in which the longer unemployment durations of movers are attributed, causally, to the time lost in transit between labor markets (see, for example, Garin, Pries and Sims, 2011, and Pilossoph, 2012).

7 Aggregate Business Cycle Patterns

We now turn to analyse the business cycle patterns implied by our calibrated model. The main results are summarised in Tables 5 and 6. These aggregate time series arise from the distributions of employed and unemployed workers across all labor markets and occupations, combined with agents' decisions. We obtain the cyclical components of the (log) of these time series by using an HP filter with smoothing parameter 1600.

Occupational Mobility and Job Separations The model is successful in creating procyclical occupational mobility, as measured by *Cm* and documented in Section 2. This arises because of the mechanism described in Lemma 4. There we showed, in a simplified setting, that the presence of search and rest unemployment can make dz^r/dp positive and lead to procyclical reallocations. This intuition also holds in the setting considered here. Figure 4 shows an upward sloping reallocation cutoff for all three human capital levels in each occupation. Further, we find that the cyclical component of *Cm* also has other properties that are consistent with the data. In both the calibrated model and in the data, *Cm* has a larger standard deviation and is more persistent than output per worker, *y*, and it exhibits less than half the volatility of unemployment. The model, however, over-predicts the cyclical volatility of *Cm*.

The model is also successful in generating a countercyclical aggregate job separation rate, *s*. Given the extent of rest unemployment, documented in the previous section, our theoretical analysis suggested this was to be expected. Figure 4 shows that dz^s/dp is negative for all three human capital levels in each occupation. As well, the calibrated model creates substantial volatility in the cyclical component of *s*. Moreover, when considering the semi-elasticity of the separation

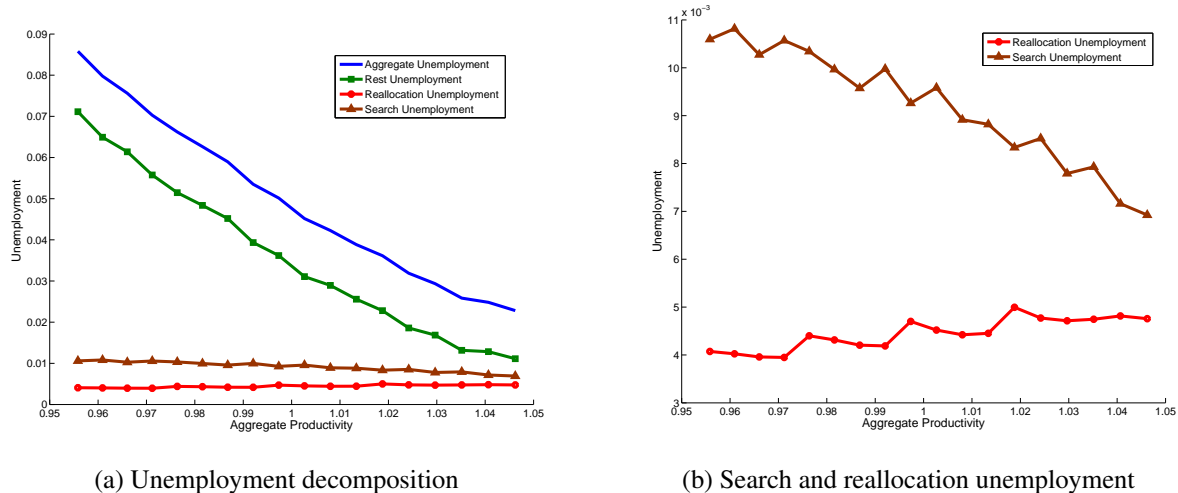

Figure 6: Unemployment decomposition

rate with respect to contemporaneous productivity, we find a strong negative relationship. In this case, the model generates a semi-elasticity of -0.06 , against -0.08 in the data.³³

Job Finding The model generates a procyclical aggregate job finding rate, f , with a slightly higher volatility than in the data. The presence of search unemployment implies that the model generates a procyclical f partly for the same reasons as in the DMP model. However, rest unemployment adds two additional forces, which also make f more volatile than in the DMP model. First, countercyclical separations into rest unemployment imply that as p increases previously rest unemployed workers will start facing a contemporaneous positive job finding probability, adding to the positive relationship between p and f . Second, procyclical reallocations from rest unemployment imply that as p increases, a larger share of unemployed workers decide to reallocate (and decides to do so earlier) to find jobs in labor markets with better conditions, further increasing f . The combination of these forces leads the model to generate a strong negative cyclical correlation between f and u , f and s ; and a positive cyclical correlation between f and y and f and Cm , as observed in the data. The model also produces a high and positive cyclical correlation between θ and f .

Aggregate Unemployment The aggregate unemployment rate in our model exhibits similar cyclical properties as in the data. Figure 6a shows that rest unemployment is the main driver of these fluctuations, exhibiting the highest response to changes in aggregate productivity. In the calibration, the cyclical behavior of rest unemployment is mainly determined by three factors: (i) the steepness of the reservation functions z^s and z^r ; (ii) the distribution of employed and unemployed workers over z -productivities; and (iii) the values of ρ_z and σ_z , which determine how workers' z -

³³The coarseness of the grid, however, means that the autocorrelation of the cyclical component of s is low, and the simulated correlations are not as high as in the data. The semi-elasticity, however, is less sensitive to this issue.

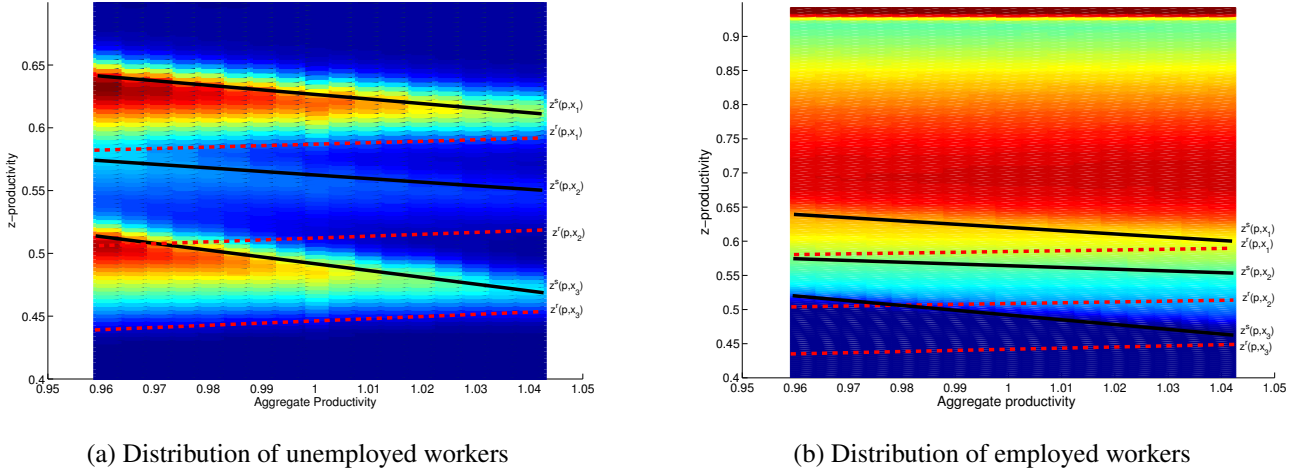

Figure 7: Distribution of workers over z and aggregate productivities

productivity evolves over time. In Section 5.3 we have studied the steepness of z^s and z^r , relating them to the presence of search and rest unemployment and the properties of the production function. Figure 7 shows a heat map representation of the distributions of unemployed and employed workers over z -productivities implied by the calibration, where the (smoothed) reservation cutoffs depicted in Figure 4 are superimposed. It shows that most of the unemployed are located between $z^s(p, x_1)$ and $z^r(p, x_1)$, between $z^s(p, x_3)$ and $z^r(p, x_3)$, and just above $z^s(p, x_1)$ and $z^s(p, x_3)$.³⁴ There is also an important mass of workers employed with z -productivities just above $z^s(p, x_1)$ and $z^s(p, x_3)$, at risk of endogenous separations. Finally, as argued earlier, our calibration yields a large ρ_z and σ_z .

These properties imply that a relative small decrease in aggregate productivity, leads to a large *increase* in the *inflow* into rest unemployment of employed and search unemployed workers with z -productivities close to the separation cutoffs. Figure 7b, for example, shows that the mass of employed workers close to the separation cutoffs increases as p decreases. The same decrease in aggregate productivity also leads to a large *decrease* in the *outflow* from rest unemployment. Indeed, Figure 7a shows that as p decreases, rest unemployment increases because (i) the intervals $[z^r(p, x_h), z^s(p, x_h)]$ widen and (ii) the density of unemployed workers at any given z within these intervals increases. The increased density at a *given* z reflects that its distance to the reallocation cutoff has now increased. This captures that in a recession, the mass of rest unemployed workers at a given z -productivity includes those workers who would have reallocated in normal times, but now preferred to ‘wait’ and subsequently experienced positive z -productivity shocks. Taken together, these forces make rest unemployment very responsive to changes in p , as evidenced in Figures 6a and 7a. Given the prominence of rest unemployment, aggregate unemployment likewise becomes very responsive to changes in p .

³⁴The small amount of unemployed worker with productivity between $z^s(p, x_2)$ and $z^r(p, x_2)$, and just above $z^s(p, x_2)$, arises because there is a smaller amount of workers who have the intermediate level of human capital.

Figure 6 shows that search unemployment does not appear to respond as much as rest unemployment to changes in p . This is due to a composition effect. Most of the search unemployed have z -productivities that are closely above the separation cutoffs (see Figure 7a). Since these workers generate small match surpluses, the job finding probabilities in their labor markets are responsive to aggregate productivity for the same reasons as discussed by Hagedorn and Manovskii (2008). Hence, an increase in aggregate productivity increases the job finding probability for these workers substantially, lowering search unemployment. The same increase in aggregate productivity, however, implies that those rest unemployed workers with z -productivities that are just below the separation cutoffs, now become search unemployed and dampen the previous decrease in search unemployment. The importance of the latter effect is governed by the steepness of z^s and is sufficient to generate the low response of search unemployment.

Figure 6 also shows that reallocation unemployment is procyclical, and has only a minor effect in dampening the cyclical fluctuations of unemployment. As discussed earlier, the small contribution of reallocation unemployment is because the time spent in transiting between occupations is small, typically less than a month, and these workers turn into rest or search unemployed before finding a job in a new occupation.³⁵

The Beveridge Curve Even though endogenous separations typically hamper the DMP model from achieving a strong negative correlation between unemployment and vacancies (the Beveridge curve), this does not happen in our model.³⁶ The cyclical correlation between aggregate unemployment and vacancies is -0.61, relative to -0.84 in the data.³⁷

The presence of rest unemployment is an important reason why the model can match to a large extent the data. With a downward sloping and steep z^s for each x_h , changes in aggregate productivity yield large changes in the amount of vacancies being created on labor markets around these cutoffs. As aggregate productivity decreases, more labor markets lie below z^s for each human capital level. In turn, no vacancies are created in those labor markets, and very few vacancies are created in labor markets associated with z -productivities just above z^s . This creates a large overall decrease in vacancy creation during downturns. As aggregate productivity increases, the opposite happens. In addition, as reallocating workers end up with z -productivities above z^s in the

³⁵Indeed, the same moments that point in favor of rest unemployment also imply that time spent in the actual reallocation process should be relatively small. Replacing rest unemployment with reallocation unemployment would create a too little occupational stayers at high unemployment durations.

³⁶In the DMP model with endogenous job destruction (Mortensen and Pissarides, 1994), productivity shocks shift the Beveridge curve, reducing vacancy fluctuations and yielding, in some cases, a positively sloped $v-u$ relation. See Mortensen and Nagypal (2007b) for a discussion. Chassamboulli (2013) finds that time-invariant productivity differences across workers helps the DMP model with endogenous separations to generate a downward sloping Beveridge curve.

³⁷The discreteness of the grids for p and z creates some jumpiness in vacancies. For example, when aggregate productivity moves one grid point up, it increases vacancies discretely, reducing their autocorrelation and the absolute value of the $v-u$ correlation. We find that increasing the grid size improves these statistics, and hence with more computational power, we expect that these correlations can become even closer.

Table 6: Semi-elasticities of the share of unemployed workers by duration

Unemp. Duration	Mean		Std. Deviation		Semi-elas. wrt y		Semi-elas. wrt u	
	Model	Data	Model	Data	Model	Data	Model	Data
$\leq 2m$	0.53	0.47	0.080	0.071	4.17	3.78	-0.28	-0.24
$\leq 4m$	0.74	0.72	0.081	0.085	3.45	1.46	-0.24	-0.23
5 – 8m	0.17	0.19	0.041	0.033	-2.14	-1.22	0.14	0.13
9 – 12m	0.06	0.05	0.027	0.028	-0.93	-0.52	0.07	0.09

new occupations, firms respond by creating more vacancies in the corresponding labor markets. Procyclical reallocations then also generates procyclical vacancy creation. Together, these forces imply that vacancies become very responsive to aggregate productivity changes, as shown in Table 5, and exhibit a high negative correlation with the aggregate unemployment rate.

Unemployment by Duration In Section 6.3 we have argued that rest unemployment creates duration dependence. Since $dz^r/dp > 0$ and $dz^s/dp < 0$ for all x_h , the distance between the reallocation and separation cutoffs varies over the business cycle (see Figures 4 and 5). This generates different implications for unemployment at different durations. Therefore, a good test of our theory would be to compare the model’s business-cycle predictions for the unemployment duration distribution with their empirical counterparts. We find that these predictions are remarkably well in line with the data.

Table 6 evaluates the ability of the model to reproduce the shifts in the incomplete unemployment duration distribution with respect to changes in output per worker, y , and the unemployment rate, u . It shows that the cyclical volatility of the shares of unemployed workers by duration (column *std. deviation*) is remarkably close to the data.³⁸ Moreover, these shares exhibit nearly the same degree of responsiveness with the business cycles as in the data. The model reproduces very well the empirical movements of these shares with respect to the aggregate unemployment rate.³⁹ In particular, as the unemployment rate increases by 10% (i.e. about half a percentage point), the *share* of incomplete unemployment spells between five and eight months increases by 1.4 percent-

³⁸The fact that the calibration matches well the mean shares of unemployed in the incomplete duration distribution is almost implied by targeting the cumulative survival rate. The main statistics here are the share of workers with unemployment spells between 0-4 months, 5-8 months and 9-12 months, since this division of durations also takes into account the seam bias present in the SIPP. In Table 6, we have also added the share of workers with unemployment spells between 0-2 months. This measure is not robust to seam bias, nor to any non-reporting of very short unemployment spells in the SIPP. As a result, we see that our model generates a measure of unemployment spells with very short duration that does not quite match the one in the SIPP (overall 0.53 in the model vs. 0.45 in the data). To the extent that the inclusion of unemployment spells that will be completed within a month simply shifts up the average share of short spells (≤ 2 months), using the semi-elasticity instead of the elasticity is helpful. With this caveat, however, we still find that the model makes predictions for the cyclical behavior of very short spells that are in line with the data.

³⁹The semi-elasticities are constructed using the cyclical component of the series of the shares of unemployed workers by durations, the aggregate unemployment rate and output per worker. Given the tight match of the responsiveness with respect to the unemployment rate, it is then not surprising that the model over-predicts the semi-elasticity of the shares with respect to output. In the data, at times when productivity has recovered but unemployment is still high, the share of long-term unemployment is also still high. This leads to a measured responsiveness lower in the data than in the model, where, almost by construction, productivity and unemployment move much closer together.

age points in the model, versus 1.3 percentage points in the data. At the same time, the increase in the unemployment rate, increases the share of unemployment spells between nine and twelve months by 0.7 percentage points, versus 0.9 in the data.

Once again rest unemployment is the mayor force behind these results. In Section 6.3, we discussed how expected unemployment outflow rates and reallocation outcomes vary in the rest unemployment interval $[z^r(p), z^s(p)]$ as a function of the distance of the worker's z -productivity to the cutoffs. Long-term unemployed workers can be found in this entire interval, but typically are at some distance from both cutoffs (where the 'risk' of leaving rest unemployment lowers the probability of becoming long-term unemployed). When aggregate productivity falls, the distance for the typical long-term unemployed worker to both cutoffs is substantially larger. As a result, at low values of p , long-term unemployed will require a sequence of more and larger good shocks to their z -productivities before becoming search unemployed in their previous occupation. They would also require a sequence of more and larger bad shocks to their z -productivities before reallocating. Hence, in a recession, the scope for remaining caught 'in limbo' between the separation and reallocation cutoffs is high for long-term unemployed workers, resulting in a low outflow rate.

In contrast, workers who have just endogenously separated tend to be close to the separation cutoff at all values of p . Since in recessions the reallocation cutoff is further away for these workers, the separation cutoff is then the one that weighs most on their future outcomes when p decreases. This implies that for workers who have just endogenously separated, the distance to the nearest cutoff is not as responsive to aggregate conditions as for the long-term unemployed. Hence, in the calibration, we observe that the outflow rate of long-term unemployed workers responds more to changes in aggregate conditions relative to the outflow rate of short-term unemployed workers. This mechanism then translates into a particularly strong increase in the share of long-term unemployed in recessions, as shown in Table 6, stronger than the one predicted based on the decline of the economy-wide average job finding rate alone.

Barnichon and Figura (2013) and Kroft et al. (2013) have argued that it is important to consider the presence of negative duration dependence when accounting for the cyclical behavior of unemployment. Kroft et al. (2013) also find that the increase in long-term unemployment is shared across occupations. This is precisely what occurs in our model: aggregate conditions interact with workers' idiosyncratic productivities in their occupation, and also interact with the idiosyncratic opportunities a worker would face if he decided to reallocate. As a result, unemployment fluctuations are amplified and long-term unemployment increases in all occupations in a recession, which results in realistic cyclical behavior of the duration distribution in the model.⁴⁰

⁴⁰Barnichon and Figura (2013) and Kroft et al. (2013) introduce, in reduced form, a negative relationship between matching efficiency and unemployment duration and show that it is quantitatively important to explain the evolution of the unemployment rate, whereas, for example, the occupational composition of unemployment is not. While in their analyses, long-term unemployed workers exogenously enter the matching technology differently than short-term unemployed workers, we build a model where negative duration dependence occurs endogenously due to the interplay of job separation and reallocation choices of the economic agents in the economy.

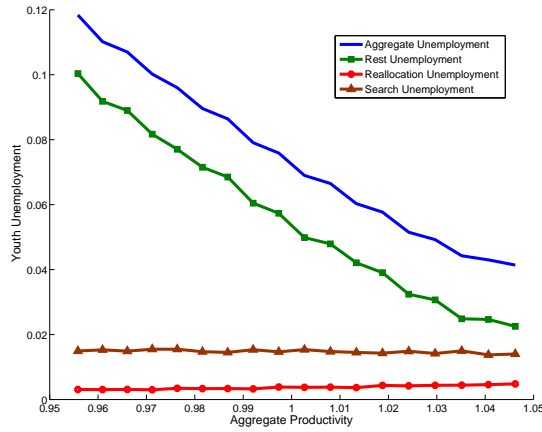

(a) Unemployment decomposition - Young Workers

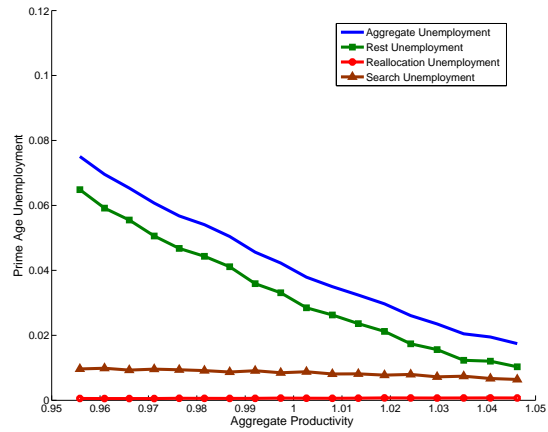

(b) Unemployment decomposition - Prime Age Workers

Figure 8: Unemployment decomposition and aggregate productivity by age groups

8 Additional Quantitative Implications

In this section we explore further the implications of occupational human capital accumulation and our assumption of random search across occupations.

8.1 Occupational Human Capital

We now turn to gauge the importance of occupational human capital accumulation on workers' degree of attachment to an occupation, in combination with the explicit time and resource cost of reallocation. Lemma 3 shows, in a simplified setting, that high levels of occupational human capital lead to more rest unemployment.⁴¹ Figure 4 shows that in our calibration rest unemployment arises in each human capital level and that the difference $z^s(p, x_h) - z^r(p, x_h)$ increases with x_h . Figure 9 aggregates workers across human capital levels and divides them into young workers (20-30 years old) and prime-aged workers (35-55 years old). This figure shows that for young workers (with typically low levels of occupational human capital) and prime-aged workers (with typically higher levels of occupational human capital), rest unemployment is the main type of unemployment and is highly responsive to changes in aggregate productivity.

Given these properties, we analyse whether the presence of rest unemployed enables the model to generate the observed patterns of young and prime-aged workers' job separation and job finding rates, their degree of occupational mobility and their unemployment duration distributions. Since in the model young and prime-aged workers only differ in their accumulated occupational human capital, this exercise allows us to show the importance of occupational human capital in determining these workers' observed unemployment and reallocation outcomes. We find that when

⁴¹ Alvarez and Shimer (2009) consider human capital and rest unemployment in a steady state setting. They focus on how the loss of human capital upon changing industries/sectors can generate the option to wait, instead of a mobility cost. We build on this by considering cyclical patterns, incorporating rest unemployment also at young ages, and estimating the importance of both the loss of occupational human capital and an fixed reallocation cost (orthogonal to human capital).

combined with the estimated time and resource costs of reallocation, occupational human capital accumulation successfully reproduces the empirical differences between these workers on the aforementioned dimensions.

Table 7 presents the average separation and job finding rates for the two groups. In the data, prime-aged workers face a lower risk of becoming unemployed than young workers. However, upon becoming unemployed, they also face a lower probability of finding a job.⁴² In the model the difference between young and prime-aged workers’ job separation rates occurs because the mass of employed workers close to separation cutoff z^s decrease with x_h . The difference between these workers’ job finding rates occurs because the increasing difference between z^s and z^r , as we increase x_h , yields a negative relation between the job finding rate and x_h . Table 7 also shows that the model reproduces well the observed cyclical volatilities, σ , of these transition rates.⁴³

Table 7: Separation and Job Finding Rates among Young and Prime-aged Workers

mean	f data	f model	s data	s model
young (20-30yo)	0.288	0.302	0.011	0.018
prime (35-55yo)	0.234	0.239	0.006	0.011
σ	f data	f model	s data	s model
young (20-30yo)	0.107	0.080	0.133	0.093
prime (35-55yo)	0.100	0.090	0.127	0.113

In addition, the larger distance between $z^s(p, x_h)$ and $z^r(p, x_h)$ at higher human capital levels implies that, while untargeted, the model can generate cumulative unemployment survival functions that are close to the data. Figure 9a shows this feature. Furthermore, Figure 9b shows that the model reproduces well the (untargeted) relationship between the change in occupational mobility with unemployment duration for each of these age groups, described in Figure 1. Their occupational mobility patterns are close to the empirical ones (maximally deviating 3-4 percentage points) for unemployment durations between 2 and 10 months. Thereafter, the relationship between occupational mobility and unemployment duration becomes non-monotone in the data, especially for the young, while in the calibration it becomes flatter.⁴⁴ Nevertheless, the model reproduce the high levels of occupation stayers at long unemployment durations among young and prime-aged

⁴²Gervais et al. (2014) consider learning about occupational fit over the life cycle in a (steady state) model with search frictions, and successfully can explain the decrease in the separation rate. The presence of rest unemployment can also explain the lower job finding rate of prime-aged workers, relative to young workers.

⁴³The separation rate in the model results from targeting the unemployment stocks of the two age groups. This rate does not perfectly coincide with the separation rate measured in the data, which considers only transitions from employment directly into unemployment. The reason for this difference is that the unemployment stocks are influenced by a positive net flow from employment to unemployment via non-participation, which typically is abstracted from in models studying the business cycle. This means that the *relative* volatilities in the model are calculated over a baseline separation rate that differs from the one in the data. When analysing the absolute volatilities of the separation rate (which are close to the relative volatilities of the *survival rate* in employment), after HP filtering, the model does very well: for young workers, we find that these cyclical volatilities are 0.0018 in the data vs 0.0016 in the model. For prime-aged workers, we find 0.0013 vs 0.0013.

⁴⁴Theoretically, the model can produce a non-monotone relationship between occupational mobility and unemployment duration. This occurs when at the highest human capital levels workers become extremely attached to their

workers. At a 12 months duration, both in the model and in the data, the remaining stock of young unemployed has more than 30% of stayers, while for prime-aged workers it has close to 40% of stayers.

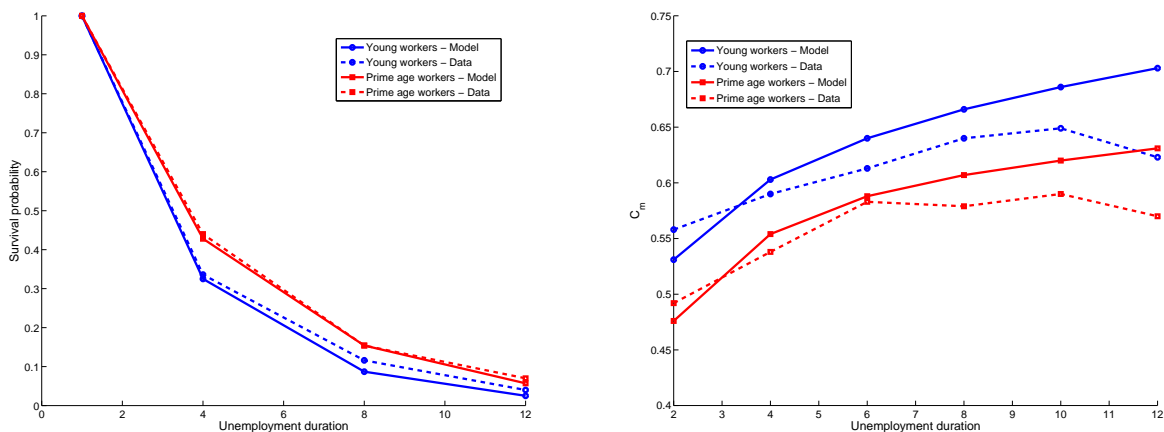

(a) Survival functions by age groups

(b) Occ. mobility and unemp. duration by age groups

Figure 9: Unemployment duration and occupational mobility by age groups

Finally, the calibrated model captures well the empirical proportions of young and prime-aged occupational stayers that did not change occupations after a subsequent unemployment spells, as documented in Section 2. In the case of young workers, the model implies that 58% of unemployed workers stayed in their occupations at the end of their second unemployment spell, while in the data we observe 56%. For prime-aged workers the proportions are 62% in the model and 65% in the data.

8.2 Random Search Across Occupations

The focus of our analysis has been on gross occupational mobility. This has been motivated by the large size of gross flows across occupations and their cyclical patterns (see Appendix C for details). This evidence suggests that gross occupational mobility is not driven by occupation-wide shocks, but instead by idiosyncratic reasons (see also Shimer, 2007). Moreover, reallocating workers are often changing occupations again after a subsequent unemployment spell. In Section 2 we found that the proportion of recent occupational movers who move in subsequent unemployment spell is as high as 56%.

In the model, repeat mobility across occupations appears to be better captured with random search across (o, z) pairs, where a reallocating worker searches sequentially across (o, z) until he finds ‘good enough’, rather than the best, labor market conditions; i.e. $z > z^r$.⁴⁵ Some workers

occupations, and these workers form a significant part of the long-term unemployed. However, with three levels of occupational human capital in the calibration, and significant mobility even for the prime-aged, this behavior is not exhibited.

⁴⁵Given that we set the length of a sampling period to a week, assuming random search across occupations does

who end up with z -productivities close to the reallocation cutoff will want to reallocate again upon receiving negative z -shocks. Indeed, while we do not target the above repeat mobility moment, our model generates a proportion of recent occupational movers who move in subsequent unemployment spell of 43%.

If, instead, workers would know from the outset the labor market conditions they will face in all occupations, they would immediately direct their search to the labor markets with the best conditions. As a result, reallocating workers would be in the best labor markets. With a persistent z -productivity process, required to match the negative duration dependence in job finding rates, this would translate, counterfactually, into a very low amount of repeat occupational mobility in adjacent unemployment spells. It would also make it harder to match the extent of occupational mobility. Further, reallocating workers would face a much lower probability of becoming endogenously unemployed. This would make it more difficult for the model to be consistent with the concentration of unemployment spells among a subset of workers as reported in Table 3.⁴⁶

To formally evaluate how important is the random search assumption in our model, we recalibrated it allowing for search across occupations to be more directed. Using all the same targets as before plus the repeat mobility of occupational movers, we allow reallocating workers to restrict their search to the set of labor markets with the best conditions. To do so, we introduce an additional parameter which controls how close are the labor market conditions available to the worker to the best conditions. Specifically, without affecting the theoretical results developed earlier, we truncate the distribution of z -productivities from below such that reallocating workers randomly draw z -productivities from $1 - F(\underline{z}_n)$, where $n = 0, 1, \dots, 100$ represents an exogenous truncation parameter such that $\underline{z}_{100} = \underline{z}$ and $\underline{z}_0 = \bar{z}$. Overall, this parameter is informed by our targeted repeat mobility moments and the other moments that we use to estimate c , ρ_z and σ_z . We find that the calibrated value of $n = 99.95$, implying that the calibration favors a nearly complete version of random search across z -productivities. The performance of the model on the other dimensions we have discussed up to now remains nearly intact.

9 Conclusions

We have presented a tractable equilibrium framework to study how unemployed workers' reallocation and separation decisions determine the evolution of the aggregate unemployment rate and the unemployment duration distribution over the business cycle. We emphasize the role of rest unemployment in successfully explaining several important features underlying these unemployment fluctuations.

not impose a significant time cost to a reallocating worker. In the calibration, a reallocating worker takes on average less than a month to find an occupation with sufficiently good labor market conditions.

⁴⁶Kambourov and Manovskii (2009a) also argued that assuming directed search across occupations might be unsatisfactory. They find that around 70% of unemployed workers in the PSID found jobs in a different occupation to the one they originally were trying to find a job. One potential way of reducing the strength of these trade-offs is by assuming that preference shocks drive workers' reallocation and job separation decisions. This seems somehow unsatisfactory since one would need large preference shocks to explain the data (see Wiczer, 2013).

Rest unemployment highlights the importance of the value of waiting for local labor market conditions to improve when making reallocation decisions. This implies that it is not necessarily optimal or socially desirable to reallocate workers when they face no immediate job prospects. This is particularly relevant when reallocation frictions are associated at least partially irreversible cost and there is enough uncertainty about the net returns to reallocation. Incorporating this insight can further inform research that aims to measure the impact of mismatch across different labor markets on unemployment fluctuations (see, for example, Şahin, et al., 2012 and Herz and Van Rens, 2011), by emphasizing the role of expectations about the future evolution of tightness in local labor markets, in addition to comparing contemporaneous labor market tightnesses.

In this paper we have focused on the model's implications for transition and duration data in several dimensions. However, our model also has implications for wage dynamics and wage dispersion. In particular, Bils et. al (2011) show that a version of the Mortensen and Pissarides (1994) model of endogenous separations with heterogeneous reservation wages across workers has difficulty in explaining the observed cyclicalities of unemployment and, at the same time, generating realistic dispersion in wage growth across workers. Our model generates these two features at the same time. Rest unemployment generates high unemployment volatility, while a disperse z -productivity process translates into a disperse distribution of wage growth across workers. Further, the variance of the aggregate wage distribution in our calibration is procyclical, as its empirical counterpart (see Morin, 2012). Nash Bargaining, however, implies the procyclicality of average wages in the model is close to that of output per worker and hence is too high compared to the estimates presented in Hagedorn and Manovskii (2008). Nevertheless, these results suggest that our model can potentially be used as a basis to study the relationship between occupational mobility, unemployment fluctuations and wages over the business cycle. We leave this topic for future research.

References

- [1] Alvarez, Fernando and Robert Shimer. 2011a. "Search and Rest Unemployment". *Econometrica*, 79 (1): 75-122.
- [2] Alvarez, Fernando and Robert Shimer. 2011b. "Unions and Unemployment". Mimeo, University of Chicago, USA.
- [3] Alvarez, Fernando and Robert Shimer. 2009. "Unemployment and Human Capital". Mimeo, University of Chicago, USA.
- [4] Alvarez, Fernando and Marcelo Veracierto. 2000. "Labor-Market Policies in an Equilibrium Search Model". NBER Macroeconomics Annual 1999, 14: 265-304.

- [5] Auray, Stephane, David Fuller, Damba Lkhagvasuren and Antoine Terracol. 2014. “A Dynamics Analysis of Sectoral Mobility, Worker Mismatch, and the Wage-Tenure Profile ”. Mimeo, CREST-Ensaï, France.
- [6] Autor, David and David Dorn. 2013. “The Growth of Low Skill Service Jobs and the Polarization of the U.S. Labor Market.” *American Economic Review*, 103 (5): 1553-1597.
- [7] Barnichon, Regis and Andrew Figura. 2013. “Labor Market Heterogeneity and the Aggregate Matching Function”. Mimeo, Universitat Pompeu Fabra, Spain.
- [8] Bils, Mark, Yongsung Chang and Sun-Bin Kim. 2011. “Worker Heterogeneity and Endogenous Separations in a Matching Model of Unemployment Fluctuations”. *American Economic Journal: Macroeconomics*, 3 (1): 128-154.
- [9] Bloom, Nicholas. 2009. “The Impact of Uncertainty Shocks ”. *Econometrica*, 77 (3): 623-685.
- [10] Carrillo-Tudela, Carlos, Bart Hobjin, and Ludo Visschers. 2014. “Career Changes Decline During Recessions ”. *FRBSF Economic Letters*, No. 2014-09.
- [11] Carrillo-Tudela, Carlos and Ludo Visschers. 2013. “Unemployment and Endogenous Reallocations Over the Business Cycle ”. IZA Working Papers No. 7124.
- [12] Chassamboulli, Andri. 2013. “Labor-Market Volatility in a Matching Model with Worker Heterogeneity and Endogenous Separations ”. *Labour Economics*, 24: 217-229.
- [13] Coles, Melvyn and Dale Mortensen. 2012. “Equilibrium Labour Turnover, Firm Growth and Unemployment”. Institute for Social and Economic Research, University of Essex, WP No. 2012-07.
- [14] Coles, Melvyn and Eric Smith. 1998. “Marketplaces and Matching ”. *International Economic Review*, 39 (1): 239-254.
- [15] Dixit, Avinash and Robert Pindyck. 1994. *Investment under Uncertainty*, 1st ed. Princeton, NJ, Princeton University Press, USA.
- [16] Dorn, David. 2009. *Essays on Inequality, Spatial Interaction, and the Demand for Skills*. Dissertation no. 3613, University of St. Gallen, Switzerland
- [17] Dvorkin, Maximiliano. 2013. “Sectoral Shocks, Reallocation and Unemployment in Competitive Labor Markets ”. Mimeo. Yale University, USA.
- [18] Ebrahimi, Ehsan and Robert Shimer. 2010. “Stock-Flow Matching”. *Journal of Economic Theory*. 145 (4): 1325-1353.

- [19] Elsby, Michael, Ryan Michaels and Gary Solon. 2009. “The Ins and Outs of Cyclical Unemployment”. *American Economic Journal: Macroeconomics*, 1 (1): 84-110.
- [20] Elsby, Michael, Bart Hobijn and Aysegul Sahin. 2010. “The Labor Market in the Great Recession”. *Brookings Papers on Economic Activity*, Spring 2010: 1-48.
- [21] Garin, Julio, Michael Pries and Eric Sims. 2011. “Reallocation and the Changing Nature of Economic Fluctuations ”. University of Notre Dame Working Paper, USA.
- [22] Faberman, Jason and Marianna Kudlyak. 2012. “The Intensity of Job Search and Search Duration”. Mimeo, Federal Reserve Bank of Richmond, USA.
- [23] Fujita, Shigeru and Guiseppe Moscarini. 2012. “Recall and Unemployment ”. Mimeo. Department of Economics, Yale University, USA.
- [24] Fujita, Shigeru and Garey Ramey. 2009. “The Cyclicalities of Separations and Job Finding Rates”. *International Economic Review*. 50 (2): 415-430.
- [25] Fujita, Shigeru, Christopher Nekarda and Garey Ramey. 2007 “The Cyclicalities of Worker Flows: New Evidence from the SIPP”. Federal Research Bank of Philadelphia, Working Paper No. 07-5.
- [26] Gomez, Victor and Agustin Maravall. 1999. “Missing observations in ARIMA models: Skipping Approach versus Additive Outlier Approach”. *Journal of Econometrics*, 88: 341-363.
- [27] Gouge, Randall, and Ian King. 1997. “A Competitive Theory of Employment Dynamics”. *Review of Economic Studies*, 64 (1): 1-22.
- [28] Gervais, Martin, Nir Jaimovich, Henry Siu and Yaniv Yedid-Levi. 2014. “What Should I Be When I Grow Up? Occupations and Unemployment over the Life Cycle”. Mimeo, University of Iowa, USA.
- [29] Hagedorn, Marcus and Iourii Manovskii. 2008. “The Cyclical Behavior of Equilibrium Unemployment and Vacancies Revisited”. *American Economic Review*, 98 (4): 1692-1706.
- [30] Hamilton, James. 1988. “A Neoclassical Model of Unemployment and the Business Cycle”. *Journal of Political Economy*, 96 (3): 593-617.
- [31] Hall, Robert and Paul Milgrom. 2008. “The Limited Influence of Unemployment on the Wage Bargain”. *American Economic Review*, 98(4): 1653-1674.
- [32] Herz, Benedikt and Thijs van Rens. 2011. “Structural Unemployment”. Mimeo, Universitat Pompeu Fabra, Spain.

- [33] Hosios, Arthur. 1991. "On the Efficiency of Matching and Related Models of Search and Unemployment". *Review of Economic Studies*, 57 (2): 279-298.
- [34] Jovanovic, Boyan and Robert Moffitt. 1990. "An Estimate of a Sectoral Model of Labor Mobility". *Journal of Political Economy*, 98 (4): 827-852.
- [35] Jovanovic, Boyan. 1987. "Work, Rest and Search: Unemployment, Turnover, and the Cycle". *Journal of Labor Economics*, 5 (2): 131-148.
- [36] Kambourov, Gueorgui and Iourii Manovskii. 2009a. "Occupational Mobility and Wage Inequality". *Review of Economic Studies*, 76 (2): 731-759.
- [37] Kambourov, Gueorgui and Iourii Manovskii. 2009b. "Occupational Specificity of Human Capital". *International Economic Review*, 50 (1): 63-115.
- [38] Kambourov, Gueorgui and Iourii Manovskii. 2008. "Rising Occupational and Industry Mobility in the United States: 1968-97". *International Economic Review*, 49 (1): 41-79.
- [39] Kaas, Leo and Philipp Kircher. 2012. "Efficient Firm Dynamics in a Frictional Labor Market". Mimeo, University of Konstanz, Germany.
- [40] Kennan, John and James Walker. 2011. "The Expected Lifetime Income of Individual Migration Decisions". *Econometrica*, 79 (1): 211-251.
- [41] Kroft, Kory, Fabien Lange, Matthew Notowidigdo and Lawrence Katz. 2013. "Long-Term Unemployment and the Great Recession: The Role of Composition, Duration Dependence, and Non-Participation". Mimeo, Harvard University, USA.
- [42] Lise, Jeremy and Jean-Marc Robin. 2012. "The Macro-dynamics of Sorting between Workers and Firms". Mimeo, University College London, UK.
- [43] Lkhagvasuren, Damba. 2012. "Big Locational Unemployment Differences Despite High Labor Mobility". *Journal of Monetary Economics*, 59 (8): 798-814.
- [44] Longhi, Simonetta and Mark Taylor. 2011. "Occupational Change and Mobility Among Employed and Unemployed Job Seekers". Institute for Social and Economic Research, University of Essex, WP No. 2011-25.
- [45] Mazumder, Bhaskar. 2007. "New Evidence on Labor Market Dynamics over the Business Cycle". *Economic Perspective*, 1Q: 36-46.
- [46] Mehrotra, Neil and Dmitriy Sergeyev. 2013. "Sectoral Shocks, the Beveridge Curve and Monetary Policy". Mimeo, Columbia University, USA.

- [47] Menzio, Guido and Shouyong Shi. 2011. “Efficient Search on the Job and the Business Cycle”. *Journal of Political Economy*, 119 (3): 468-510.
- [48] Morin, Annaig. 2012. “Wage Dispersion over the Business Cycle ”. Mimeo. European University Institute, Italy.
- [49] Mortensen, Dale. 2009. “Island Matching”. *Journal of Economic Theory*, 144: 2336-2353.
- [50] Mortensen, Dale and Eva Nagypal. 2007a. “More on Unemployment and Vacancy Fluctuations”. *Review of Economic Dynamics*, 10: 327-347.
- [51] Mortensen, Dale and Eva Nagypal. 2007b. “Labor-market Volatility in Matching Models with Endogenous Separations”. *Scandinavian Journal of Economics*, 109 (4): 645-665.
- [52] Mortensen, Dale and Christopher Pissarides. 1994. “Job Creation and Job Destruction in the Theory of Unemployment”. *Review of Economic Studies*, 61 (3): 397-415.
- [53] Moscarini, Guiseppe and Fabien Postel-Vinay. 2013. “Stochastic Search Equilibrium”. *Review of Economic Studies*, 80 (4): 1545-81.
- [54] Moscarini, Guiseppe and Francis Vella. 2008. “Occupational Mobility and the Business Cycle”. Mimeo, Yale University, USA.
- [55] Moscarini, Guiseppe and Kaj Thomsson. 2007. “Occupational and Job Mobility in the US”. *Scandinavian Journal of Economics*, 109 (4): 807-836.
- [56] Murphy, Kevin and Robert Topel. 1987. “The Evolution of Unemployment in the United States: 1968 - 1985”. NBER Macroeconomics Annual 1987, 2: 11-68.
- [57] Murtin, Fabrice and Jean-Marc Robin. 2013. “Labor Market Reforms and Unemployment Dynamics”. Mimeo, Science Po, France.
- [58] Nagypal, Eva. 2008. “Worker Reallocation over the Business Cycle: The Importance of Employer-To-Employer Transitions”. Mimeo, Northwestern University, USA.
- [59] Papageorgiou, Theodore. 2013. “Worker Sorting and Agglomeration Economies ”. Mimeo, Penn State University, US.
- [60] Petrongolo, Barbara and Christopher Pissarides. 2001. “Looking into the Black Box: A Survey of the Matching Function”. *Journal of Economic Literature*, 39: 390-43.
- [61] Pilosoph, Laura. 2012. “A Multisector Equilibrium Search Model of Labor Reallocation”. Mimeo, University of Chicago, USA.

- [62] Pissarides, Christopher. 2001. *Equilibrium Unemployment Theory*, 2nd ed. Cambridge, MA, MIT Press, USA.
- [63] Robin, Jean-Marc. 2011. “On the Dynamics of Unemployment and Wage Distributions”. *Econometrica*, 79(5): 1327-1355.
- [64] Sahin, Aysegul, Joseph Song, Giorgio Topa and Giovanni L. Violante. 2012. “Mismatch in the Labor Market: Evidence from the UK and the US”. Mimeo, New York University.
- [65] Shimer, Robert. 2012. “Reassessing the Ins and Outs of Unemployment”. *Review of Economic Dynamics*, 15: 127-148.
- [66] Shimer, Robert. 2008. “The Probability of Finding a Job”. *American Economic Review: Papers and Proceedings*, 98 (2): 268-273.
- [67] Shimer, Robert. 2007. “Mismatch”. *American Economic Review*, 97 (4): 1074-1101.
- [68] Shimer, Robert. 2005. “The Cyclical Behavior of Equilibrium Unemployment and Vacancies”. *American Economic Review*, 95 (1): 25-49.
- [69] Stinson, Martha. 2003. “Technical Description of SIPP Job Identification Number Editing in the 1990-1993 SIPP Panels”. US Census. [http : //www.nber.org/sipp/1991/sipp90_3jid.pdf](http://www.nber.org/sipp/1991/sipp90_3jid.pdf)
- [70] Stokey, Nancy. 2008. *The Economics of Inaction: Stochastic Control Models with Fixed Costs*, 1st ed. Princeton, NJ, Princeton University Press, USA.
- [71] Veracierto, Marcelo. 2008. “On the Cyclical Behavior of Employment, Unemployment and Labor Force Participation”. *Journal of Monetary Economics*, 55: 1143-1157.
- [72] Wiczer, David. 2013. “Long-term Unemployment: Attached and Mismatched?” Mimeo, University of Minnesota, USA.
- [73] Williams, Nicolas. 2009. “Seniority, Experience, and Wages in the UK ”. *Labour Economics*, 16: 272-283.
- [74] Wong, Jacob. 2011. “Aggregate Reallocation Shocks and the Dynamics of Occupational Mobility and Wage Inequality”. Mimeo, University of Adelaide, Australia.
- [75] Xiong, Hui. 2008. “The U.S. Occupational Mobility from 1988 to 2003: Evidence from SIPP”. Mimeo, University of Toronto, Canada.

Appendix A

In this appendix we have collected the proofs of the results stated in Section 4. To keep notation complexity to a minimum we make implicit the subscript h in x_h , making it explicit only when necessary.

Proof of Proposition 1 We divide the proof into two steps. In the first step we derive the operator T and show it is a contraction. In the second step we construct the candidate equilibrium functions from the fixed point value and policy functions of T , and verify these satisfy all equilibrium conditions.

Step 1 Let $M(p, z, x) \stackrel{def}{=} W^E(p, z, x) + J(p, z, x)$ denote the value of the match. We want to show that the value functions $M(p, z, x)$ and $W^U(p, z, x)$ exist. This leads to a two dimensional fixed point problem. It is then useful to define the operator T that maps the value function $\Gamma(p, z, x, n)$ for $n = 0, 1$ into the same function space, such that $\Gamma(p, z, x, 0) = M(p, z, x)$, $\Gamma(p, z, x, 1) = W^U(p, z, x)$, as

$$T(\Gamma(p, z, x, 0)) = y(p, z, x) + \beta \mathbb{E}_{p', z', x'} \left[\max_{d^T} \{ (1 - d^T) M(p', z', x') + d^T W^U(p', z', x') \} \right],$$

$$T(\Gamma(p, z, x, 1)) = b + \beta \mathbb{E}_{p', z'} \left[\max_{\rho^T} \left\{ \rho^T \left(\int W^U(p', \tilde{z}, x_1) dF(\tilde{z}) - c \right) + (1 - \rho^T) (S^T(p', z', x) + W^U(p', z', x)) \right\} \right],$$

where by virtue of the free entry condition and the definition of $M(p, z, x)$,

$$S^T(p', z', x) \equiv \lambda(\theta(p', z', x)) \left(M(p', z', x) - W^U(p', z', x) \right) - \theta(p', z', x)k.$$

Lemma A.1: T is (i) a well-defined operator mapping functions from the closed space of bounded continuous functions Γ into itself, (ii) a contraction and (iii) maps functions $M(p, z, x_h)$ and $W^U(p, z, x_h)$ that are increasing in z into itself.

First we show that the operator T maps continuous functions into continuous functions. Note that $\theta \in [0, 1]$, for all p, z, x and $W^U(p, z, x)$, $M(p, z, x)$, $\lambda(\theta)$ and $S(p, z, x)$ are continuous functions. Since $\max\{M(p', z', x'), W^U(p', z', x')\}$ is also a continuous function, it follows that T maps continuous functions into continuous functions. Moreover, since the domain of p, z, x is bounded, the resulting continuous functions are bounded.

To show that T defines a contraction, consider two functions Γ, Γ' , such that $\|\Gamma - \Gamma'\|_{\text{sup}} < \varepsilon$. Then it follows that $\|W^U(p, z, x) - W^{U'}(p, z, x)\|_{\text{sup}} < \varepsilon$ and $\|M(p, z, x) - M'(p, z, x)\|_{\text{sup}} < \varepsilon$, where W^U, M are part of Γ as defined in the text. Since $\|\max\{a, b\} - \max\{a', b'\}\| < \max\{\|a - a'\|, \|b - b'\|\}$, as long as the terms over which to maximize do not change by more than ε in

absolute value, the maximized value does not change by more ε . The only maximization for which it is nontrivial to establish this is $\max\{\int W^U(p, z, x_1)dF(z) - c, S(p, z, x) + W^U(p, z, x)\}$. The first part can be established readily: $\|\int (W^U(p, z, x_1) - W^{U'}(p, z, x))dF(z)\|_{\text{sup}} < \varepsilon$. We now show that this property holds for $\|S(p, z, x) + W^U(p, z, x) - S'(p, z, x) - W^{U'}(p, z, x)\|_{\text{sup}}$.

Consider first the case that $M - W > M' - W'$, where M stands for $M(p, z, x)$ and W stands for $W^U(p, z, x)$. Then, we must have $\varepsilon > W' - W \geq M' - M > -\varepsilon$. Construct $M'' = W' + (M - W) > M'$ and $W'' = M' - (M - W) < W'$. Since $S(M - W) = \lambda(\theta)(M - W) - \theta k$ and likewise $S(M' - W')$, we have that

$$\begin{aligned} -\varepsilon < S(M' - W'') + W'' - S(M - W) - W &\leq S(M' - W') + W' - S(M - W) - W \\ &\leq S(M'' - W') + W' - S(M - W) - W < \varepsilon \end{aligned}$$

where $S(M' - W'') = S(M - W) = S(M'' - W')$ by construction. Note that the outer inequalities follow because $M - M' > -\varepsilon, W' - W < \varepsilon$.

Likewise, consider the case where $M' - W' > M - W \geq 0$. Then

$$\begin{aligned} \varepsilon > S(M' - W'') + W'' - S(M - W) - W &> S(M' - W') + W' - S(M - W) - W \\ &> S(M'' - W') + W' - S(M - W) - W > -\varepsilon \end{aligned}$$

Hence $\|S(p, z, x) + W^U(p, z, x) - S'(p, z, x) - W^{U'}(p, z, x)\|_{\text{sup}} < \varepsilon$. It then follows that $\|T(\Gamma(p, z, x, 1)) - T(\Gamma'(p, z, x, 1))\| < \beta\varepsilon$ for all p, z, x , and $\|\Gamma - \Gamma'\| < \varepsilon$. Hence, the operator is a contraction.

It is now trivial to show that if M and W^U are increasing in z , T maps them into increasing functions. This follows since the $\max\{M(p', z', x'), W^U(p', z', x')\}$ is also an increasing function. Assumption 1 is needed so higher z today implies (on average) higher z tomorrow. Since the value of reallocation is constant in z , a reservation policy for reallocation follows immediately.

Step 2: From the fixed point functions $M(p, z, x)$ and $W^U(p, z, x)$ define the function $J(p, z, x) = \max\{(1 - \alpha)[M(p, z, x) - W^U(p, z, x)], 0\}$, and the functions $\theta(p, z, x)$ and $V(p, z, x)$ from $0 = V(p, z, x) = -k + q(\theta(p, z, x))J(p, z, x)$. Also define $W^E(p, z, x) = M(p, z, x) - J(p, z, x)$ if $M(p, z, x) > W^U(p, z, x)$, and $W^E(p, z, x) = M(p, z, x)$ if $M(p, z, x) \leq W^U(p, z, x)$. Finally, define $\delta(p, z, x) = \delta^T(p, z, x)$, $\sigma(p, z, x) = \delta^T(p, z, x)$, $\rho(p, z, x) = \rho^T(p, z, x)$ and $w(p, z, x)$ derived using (5) given all other functions.

Given $1 - \alpha = \eta$ and (5), (4) is satisfied, provided the separation decisions between the worker and firm coincide, which is the case as the matches are broken up if and only if it is efficient to do so according to $M(p, x, z)$ and $W^U(p, x, z)$. Equation (2) is then satisfied by construction, $\theta(p, z, x)$ satisfies the free entry condition and $w(p, z, x)$ satisfies (5). Hence, the constructed value functions and decision rules satisfy all conditions of the equilibrium, and the implied evolution of the distribution of employed and unemployed workers will also be the same.

Uniqueness follows from the same procedure in the opposite direction, by contradiction. Sup-

pose the block recursive equilibrium is not unique. Then a second set of functions exists that satisfy the equilibrium conditions. Construct \hat{M} and \hat{W}^U from these. Since in any equilibrium the breakup decisions have to be efficient and the reallocation and job application decisions are captured in T , \hat{M} and \hat{W}^U must be a fixed point of T , contradicting the uniqueness of the fixed point established by Banach's Fixed Point Theorem: hence, there is a unique BRE.

This completes the proof of Proposition 1.

Proof of Proposition 2 Recall that Ω^j denotes the general state space and \mathcal{E}^j denotes the distribution of unemployed and employed workers over the different labor markets and occupations at the beginning of stage j . Recall that we let next period's values be denoted by a prime. The planner's problem can then be written in recursive form using the mapping T^{SP} ,

$$\begin{aligned} T^{SP}W^{SP}(\Omega^p) = & \max_{\{d(p',z',x'_h,\mathcal{E}^s),\rho(p',z',x'_h,\mathcal{E}^r),v(p',z',x'_h,\mathcal{E}^m)\}} \sum_{o=1}^O \sum_{h=1}^H \int_{\underline{z}}^{\bar{z}} (u_o(z,x_h)b + e_o(z,x_h)y(p,z,x_h))dz \\ & + \beta \mathbb{E}_{p',z',x'_h} \left[- \left(c \sum_{o=1}^O \sum_{h=1}^H \int_{\underline{z}}^{\bar{z}} \rho(p',z',x'_h,\mathcal{E}^r) u_o(z',x'_h) dz' + k \sum_{o=1}^O \sum_{h=1}^H \int_{\underline{z}}^{\bar{z}} v_o(p',z',x'_h,\mathcal{E}^m) dz' \right) \right. \\ & \left. + W^{SP}(\Omega^{p'}) \right] \end{aligned}$$

subject to laws of motions

$$\begin{aligned} u'_o(z,x_h)dz &= \int_{\underline{z}}^{\bar{z}} (1 - \lambda(\theta(p,\tilde{z},x_h,\mathcal{E}^m)))(1 - \rho(p,\tilde{z},x_h,\mathcal{E}^r))u_o(\tilde{z},x_h)dF(z|\tilde{z})d\tilde{z} \\ &+ \int_{\underline{z}}^{\bar{z}} d(p,\tilde{z},x_h,\mathcal{E}^s)e_o(\tilde{z},x_h)dF(z|\tilde{z})d\tilde{z} \\ &+ (\mathbf{1}_{h=1}) \left[\sum_{\tilde{o} \neq o}^H \sum_{h=1}^H \left[\int_{\underline{z}}^{\bar{z}} \rho(p,\tilde{z},\tilde{x}_h,\mathcal{E}^r)u_{\tilde{o}}(\tilde{z},\tilde{x}_h)d\tilde{z} \right] \right] \frac{dF(z)}{O-1}. \end{aligned}$$

$$\begin{aligned} e'_o(z,x_h)dz &= \chi(x_h|x_h) \int_{\underline{z}}^{\bar{z}} \lambda(\theta(p,\tilde{z},x_h,\mathcal{E}^m))(1 - \rho(p,\tilde{z},x_h,\mathcal{E}^r))u_o(\tilde{z},x_h)dF(z|\tilde{z})d\tilde{z} \\ &+ \chi(x_h|x_h) \int_{\underline{z}}^{\bar{z}} (1 - d(p,\tilde{z},x_h,\mathcal{E}^s))e_o(\tilde{z},x_h)dF(z|\tilde{z})d\tilde{z} \\ &+ (\mathbf{1}_{h>1}) \left[\chi(x_h|x_{h-1}) \int_{\underline{z}}^{\bar{z}} (1 - d(p,\tilde{z},x_{h-1},\mathcal{E}^s))e_o(\tilde{z},x_{h-1})dF(z|\tilde{z})d\tilde{z} \right], \end{aligned}$$

and initial conditions p_0 and \mathcal{E}_0 . For each pair (z, x_h) the social planner must decide whether to (i) reallocate workers, $\rho(\cdot)$, (ii) break up job matches, $d(\cdot)$, and (iii) set the number of vacancies for the unemployed, $v(\cdot)$, given aggregate productivity p and the values of z , and potentially the distribution of workers over labor markets. With $v(\cdot) = \theta(\cdot)(1 - \rho(\cdot))u(z, x_h)$, we can substitute the vacancy creation decision by a decision on labor market tightness.

Note that W^{SP} is linear in $u(z, x_h)$ and $e(z, x_h)$, where $u(z, x_h) = \sum_{o \in O} u_o(z, x_h)$ and $e(z, x_h)$ is analogously defined. Hence, T^{SP} maps these linear functions into a function that is likewise linear in these variables. Linearity of W^{SP} implies that we can define $W^U(p, z, x_h)$ and $M(p, z, x_h)$ such that W^{SP} can be written as

$$W^{SP}(p, \Omega) = \sum_{h=1}^H \int_{\underline{z}}^{\bar{z}} (W^U(p, z, x_h)u(z, x_h) + M(p, z, x_h)e(z, x_h)) dz.$$

Hence we can write

$$\begin{aligned} T^{SP}W^{SP}(p, \Omega) = & \max_{d(\cdot), \rho(\cdot), \theta(\cdot)} \sum_{h=1}^H \int_{\underline{z}}^{\bar{z}} \left(u(z, x_h)b + \beta \mathbb{E}_{p', z'} \left[\left(\int_{\underline{z}}^{\bar{z}} W^U(p', \tilde{z}, x_1) dF(\tilde{z}) - c \right) \rho(p', z', x_h) \right. \right. \\ & + (1 - \rho(p', z', x_h)) \left[\lambda(\theta(p', z', x_h)) M(p', z', x_h) - \theta(p', z', x_h)k \right. \\ & \left. \left. + (1 - \lambda(\theta(p', z', x_h))) W^U(p', z', x_h) \right] \Big| p, z, x_h \right] u(z, x_h) \\ & + e(z, x_h)y(p, z, x_h) + \beta \mathbb{E}_{p', z', x'_h} \left[\left[(1 - d(p', z', x'_h)) M(p', z', x'_h) + \right. \right. \\ & \left. \left. + d(p', z', x'_h) W^U(p', z', x'_h) \right] \Big| p, z, x_h \right] e(z, x_h) \Big) dz, \end{aligned}$$

where implicitly we have already used the notion that when W^{SP} is linear in $e(z, x_h)$ and $u(z, x_h)$, then decisions $\rho(\cdot), d(\cdot), \theta(\cdot)$ are only functions of (p, z, x_h) . Further, we can completely isolate the terms with $u(z, x_h)$ and $e(z, x_h)$ and take the maximization over the remaining terms such that

$$T^{SP}W^{SP}(p, \Omega) = \sum_{h=1}^H \int_{\underline{z}}^{\bar{z}} [W_{max}^U(p, z, x_h)u(z, x_h) + M_{max}(p, z, x_h)e(z, x_h)] dz$$

where

$$\begin{aligned} W_{max}^U(p, z, x_h) = & \max_{\rho(p', z', x_h), v(p', z', x_h)} \left\{ b + \beta \mathbb{E}_{p', z'} \left[\left(\int_{\underline{z}}^{\bar{z}} W^U(p', \tilde{z}, x_1) dF(\tilde{z}) - c \right) \rho(p', z', x_h) \right. \right. \\ & \left. \left. + (1 - \rho(p', z', x_h)) \left[\lambda(\theta(p', z', x_h)) \left[M(p', z', x_h) - W^U(p', z', x_h) \right] - \theta(p', z', x_h)k + W^U(p', z', x_h) \right] \right\}, \end{aligned}$$

$$M_{max}(p, x, z) =$$

$$\max_{d(p', z', x'_h)} \left\{ y(p, z, x_h) + \beta \mathbb{E}_{p', z', x'_h} \left[\left(d(p', z', x'_h) W^U(p', z', x'_h) + (1 - d(p', z', x'_h)) M(p', z', x'_h) \right) \right] \right\}.$$

The maximized value depends only on p, z and x_h , and hence T^{SP} maps a value function that is

linear in $u_o(z, x_h)$ and $e_o(z, x_h)$ into a value function with the same properties. Moreover, using the definitions of W_{max}^U and M_{max} it follows that from the fixed point of the mapping T^{SP} we can derive a W_{max}^{U*} and M_{max}^* that constitutes a fixed point to T , and vice versa. Hence, the allocations of the fixed point of T are allocations of the fixed point of T^{SP} , and hence the equilibrium allocation is the efficient allocation. This completes the proof of Proposition 2.

BRE gives the unique equilibrium allocation Here we show that in any equilibrium, decisions and values are only functions of (p, z, x_h) . To do so, suppose there is an alternative equilibrium in which values and decisions do not depend only on (p, z, x_h) , but also on a fourth factor – like the entire distribution of workers over employment status and z -productivities, or its entire history of observables, H_t . Consider the associated value functions in this alternative equilibrium, where the relevant state vector of the alternative equilibrium is given by (p, z, x_h, H_t) . We now show that such an equilibrium cannot exist.

First, suppose that in the alternative equilibrium all value functions are the same as in the BRE, but decisions differ at the same (p, z, x_h) . This violates the property that, in our setting, all maximizers in the BRE value functions are unique, leading to a contradiction.

Next suppose that in the alternative equilibrium at least one value function differs from the corresponding BRE value function at the same (p, z, x_h) . It is straightforward to show that the expected values of unemployment must differ in both equilibria. Let $W^U(p, z, x_h, H_t)$ denote the value function for unemployed workers in the alternative (non-block recursive) equilibrium, and let $W^U(p, z, x_h)$ denote the corresponding value function in the BRE for the same (p, z, x_h) . In Proposition 2, we showed that the BRE is constrained efficient. Since that proof did not rely on the uniqueness of the BRE in the broader set of all equilibria, we can use the proved results of Proposition 2 here.

In particular, it is crucial to note that the proof of Proposition 2 establishes that the social planner's problem is entirely linear in the distribution of workers across states, and hence that $W^U(p, z, x_h)$ is the best the unemployed worker with (p, z, x_h) can do (without transfers), including in the market equilibrium (from Proposition 1). Likewise, $M(p, z, x_h)$ is the highest value of the joint value of a match, including in the market equilibrium. In addition, value functions must be bounded from above and from below, and are continuous in their state variables. Hence there exists a supremum of the difference between $W^U(p, z, x_h)$ and the candidate market equilibrium's $W^U(p, z, x_h, H_t)$, $\sup(W^U(p, z, x_h) - W^U(p, z, x_h, H_t)) = k_u > 0$. Similarly, since M is bounded from below, there also exists a supremum for the difference between these two value functions, $\sup(M(p, z, x_h) - M(p, z, x_h, H_t)) = k_m > 0$. In what follows, we show that a difference in unemployment values, or match values, arbitrarily close to $k_u > 0$, resp. $k_m > 0$, cannot occur, as it requires the difference in *tomorrow's* values to be larger than k_u , resp. k_m . In turn, this implies that the alternative equilibrium cannot exist.

From the above definition of supremum, it follows that $\max\{M(p, z, x_h), W^U(p, z, x_h)\} -$

$\max\{M(p, z, x_h, H_t), W^U(p, z, x_h, H_t)\} < \max\{k_u, k_m\}$. Since

$$M(p, z, x_h) = y(p, x_h, z) + \beta \mathbb{E}[\max\{M(p', x'_h, z'), W^U(p', x'_h, z')\}],$$

and likewise for $M(p, z, x_h, H_t)$ it follows that at any (p, z, x_h, H_t) ,

$$M(p, z, x_h) - M(p, z, x_h, H_t) < \beta \max\{k_u, k_m\}. \quad (14)$$

Consider first $k_m \geq k_u$. For (p, z, x_h, H_t) achieving a match value difference $(M(p, z, x_h) - M(p, z, x_h, H_t))$ larger than βk_m , then equation (14) leads to a contradiction with $k_m > 0$.

Consider, second, $k_u > k_m$. Simplifying notation by dropping (p, x_h, z) and using the prime instead of (p, x_h, z, H_t) , we establish first an intermediate claim: that at *any* (p, z, x_h, H_t) , the following holds:

$$\lambda(\theta)(1 - \eta)M + (1 - \lambda(\theta)(1 - \eta))W < \lambda(\theta')(1 - \eta)M' + (1 - \lambda(\theta')(1 - \eta))W' + k_u. \quad (15)$$

There are two cases. Case 1: $(M' - W') \geq M - W$; then $\lambda(\theta') \geq \lambda(\theta)$. Define $K = (1 - \eta)(\lambda(\theta') - \lambda(\theta))(M' - W') \geq 0$. Combining this with $\lambda(\theta)(1 - \eta)(M - M') + (1 - \lambda(\theta)(1 - \eta))(W - W') \leq k_u$, it must be true that

$$\lambda(\theta)(1 - \eta)(M - M') + (1 - \lambda(\theta)(1 - \eta))(W - W') - K \leq k_u, \quad (16)$$

from which (15) follows.

Now consider case 2: suppose that $(M - W) > (M' - W')$; then $\lambda(\theta) > \lambda(\theta')$. From the derivative of $\frac{d}{d(M-W)}(\lambda(\theta)(M - W))(1 - \eta)(M - W) = \lambda(\theta)(M - W)$, we can establish that, if $(M - W) > (M' - W')$,

$$\lambda(\theta)((M - W) - (M' - W')) > \lambda(\theta)(1 - \eta)(M - W) - \lambda(\theta')(1 - \eta)(M' - W') > \lambda(\theta')((M - W) - (M' - W')).$$

We can use this, because in any equilibrium (not only in the BRE) θ' depends only on $(M' - W')$ and unchanging parameters. Using this, we can establish that

$$W + \lambda(\theta)(M - W) - (W' + \lambda(\theta')(M' - W')) < k_u,$$

from which (15) follows.

Finally consider a (p, z, x_h, H_t) such that $\max\{k_m, \beta^{-1}k_u\} < W^U(p, z, x_h) - W^U(p, z, x_h, H_t) < k_u$; such a (p, z, x_h, H_t) exists by the definition of supremum. It is now straightforward to check that the difference in *tomorrow's* value (under the expectation sign), between $W^U(p, x_h, z)$ and $W^U(p, x_h, z, H_t)$ will not exceed k_u , since term-by-term, the difference is bounded by k_u . However, this also implies that today's difference in the aforementioned values, $W^U(p, z, x_h) - W^U(p, z, x_h, H_t)$, cannot be more than $\beta k_u > 0$, which contradicts our premise.

Appendix B

In this appendix we derive the results described in the Section 5 in which we restrict the state space to (p, z) . In Carrillo-Tudela and Visschers (2013) we provide a full characterisation of this version. We first show that there exist a separation cutoff function z^s . Then we use a steady state version of the model to analyse the relative position and slopes of z^r and z^s .

Proof of Lemma 1 Consider the same operator T defined in the proof of Proposition 1, but now the relevant state space is given by (p, z) . Note that the value functions (1) - (4), describing the worker's and the firm's problem, do not change, except for the fact that we are using a smaller state space. It is straightforward to verify that the derived properties of T in Lemma A.1 also apply in this case. We now want to show that this operator maps the subspace of functions Γ into itself with $M(p, z)$ increasing weakly faster in z than $W^U(p, z)$. To show this, take $M(p, z)$ and $W^U(p, z)$ such that $M(p, z) - W^U(p, z)$ is weakly increasing in z and let z^s denote a reservation productivity such that for $z < z^s$ a firm-worker match decide to terminate the match. Using $\lambda(\theta)(M - W^U) - \theta k = \lambda(\theta)(M - W^U) - \lambda'(\theta)(M - W^U)\theta = \lambda(\theta)(1 - \eta)(M - W^U)$, we construct the following difference

$$\begin{aligned}
 T\Gamma(p, z, 0) - T\Gamma(p, z, 1) = & \tag{17} \\
 & y(p, z) - b + \beta \mathbb{E}_{p', z'} \left[(1 - \delta) \max\{M(p', z') - W^U(p', z'), 0\} - \right. \\
 & \left. \max \left\{ \int W^U(p', \tilde{z}) dF(\tilde{z}) - c - W^U(p', z'), \lambda(\theta)(1 - \eta)(M(p', z') - W^U(p', z')) \right\} \right].
 \end{aligned}$$

The first part of the proof shows the conditions under which $T\Gamma(p, z, 0) - T\Gamma(p, z, 1)$ is weakly increasing in z . Because the elements of the our relevant domain are restricted to have $W^U(p, z)$ increasing in z , and $M(p, z) - W^U(p, z)$ increasing in z , we can start to study the value of the term under the expectation sign, by cutting a number of different cases to consider depending on where z' is relative to the implied reservation cutoffs.

– *Case 1.* Consider the range of tomorrow's $z' \in [z(p'), z^r(p'),)$, where $z^r(p') < z^s(p')$. In this case, the term under the expectation sign in the above equation reduces to $-\int W^U(p', x_1, \tilde{z}) dF(\tilde{z}) + c + W^U(p', z')$, which is increasing in z' .

– *Case 2.* Now suppose tomorrow's $z' \in [z^r(p'), z^s(p')]$. In this case, the term under the expectation sign becomes zero (as $M(p', z') - W^U(p', z') = 0$), and is therefore constant in z' .

– *Case 3.* Next suppose that $z' \in [z^s(p'), z^r(p')]$. In this case, the entire term under the expectation sign reduces to

$$(1 - \delta)(M(p', z') - W^U(p', z')) - \int W^U(p', \tilde{z}) dF(\tilde{z}) + c + W^U(p', z'),$$

and, once again, is weakly increasing in z' , because by supposition $M(p', z') - W^U(p', z')$ is weakly increasing in z' , and so is $W^U(p', z')$ by Lemma A.1.

– *Case 4.* Finally consider the range of $z' \geq \max\{z^r(p'), z^s(p')\}$, such that in this range employed workers do not quit nor reallocate. In this case the term under the expectation sign equals

$$(1 - \delta)[M(p', z') - W^U(p', z')] - \lambda(\theta(p', z'))(1 - \eta)[M(p', z') - W^U(p', z')]. \quad (18)$$

It is easy to show using the free entry condition that $\frac{d(\lambda(\theta^*(p', z'))(1 - \eta)[M(p', z') - W^U(p', z')])}{d(M - W)} = \lambda(\theta(p', z'))$, and hence that the derivative of (18) with respect to z' is positive whenever $1 - \delta - \lambda(\theta) \geq 0$.

Given Assumption 1, the independence of z of x, p , and that the term under the expectation sign are increasing in z' , given any p' , it follows that the integral in (17) is increasing in today's z . Together with $y(p, z)$ increasing in z , it must be that $T\Gamma(p, z, 1) - T\Gamma(p, z, 0)$ is also increasing in z .

To establish that the fixed point also has increasing differences in z between the first and second coordinate, we have to show that the space of this functions is closed in the space of bounded and continuous functions. In particular, consider the set of functions $F \stackrel{def}{=} \{f \in \mathcal{C} | f : X \times Y \rightarrow \mathbb{R}^2, |f(x, y, 1) - f(x, y, 2)| \text{ increasing in } y\}$, where $f(\cdot, \cdot, 1), f(\cdot, \cdot, 2)$ denote the first and second coordinate, respectively, and \mathcal{C} the metric space of bounded and continuous functions endowed with the sup-norm.

The next step in the proof is to show that fixed point of $T\Gamma(p, z, 0) - T\Gamma(p, z, 1)$ is also weakly increasing in z . To show we first establish the following result.

Lemma B.1: *F is a closed set in \mathcal{C}*

Proof. Consider an $f' \notin F$ that is the limit of a sequence $\{f_n\}, f_n \in F, \forall n \in \mathbb{N}$. Then there exists an $y_1 < y$ such that $f'(x, y_1, 1) - f'(x, y_1, 2) > f'(x, y, 1) - f'(x, y, 2)$, while $f_n(x, y_1, 1) - f_n(x, y_1, 2) \leq f_n(x, y, 1) - f_n(x, y, 2)$, for every n . Define a sequence $\{s_n\}$ with $s_n = f_n(x, y_1, 1) - f_n(x, y_1, 2) - (f_n(x, y, 1) - f_n(x, y, 2))$. Then $s_n \geq 0, \forall n \in \mathbb{N}$. A standard result in real analysis guarantees that for any limit s of this sequence, $s_n \rightarrow s$, it holds that $s \geq 0$. Hence $f'(x, y_1, 1) - f'(x, y_1, 2) \leq f'(x, y, 1) - f'(x, y, 2)$, contradicting the premise. \square

Thus, the fixed point exhibits this property as well and the optimal quit policy is a reservation- z policy given $1 - \delta - \lambda(\theta) > 0$. Since $y(p, z)$ is strictly increasing in z , the fixed point difference $M - W^U$ must also be strictly increasing in z . Furthermore, since $\lambda(\theta)$ is concave and positively valued, $\lambda'(\theta)(M - W^U) = k$ implies that job finding rate is also (weakly) increasing in z . This completes the proof of Lemma 1.

Stationary Model

We now derive the proofs of Lemmas 2, 3 and 4, using the stationary versions of (1) - (4) and restricting the state space to (p, z) . Note that p is fixed and does not change over time. However, each period, with probability $(1 - \gamma)$, the z -productivity of a worker is redrawn in an iid fashion from $F(\cdot)$, the unconditional distribution of z in any occupation. The matching function within a

labor market is assumed to be Cobb-Douglas, wages are determined through Nash Bargaining with $\eta = 1 - \alpha$ and free entry of firms occurs at each labor market. In this environment, the expected value of unemployment for a worker currently with productivity z in occupation o ,

$$W^U(p, z) = \gamma \left(b + \beta \max \left\{ R(p), W^U(p, z) + \max \{ \lambda(\theta(p, z))(1 - \eta)(M(p, z) - W^U(p, z)), 0 \} \right\} \right) + (1 - \gamma) \mathbb{E}_z[W^U(p, z)]. \quad (19)$$

where the expected value of reallocation

$$R(p) = -c + \int_{\underline{z}}^{\bar{z}} W^U(p, \tilde{z}) dF(\tilde{z}). \quad (20)$$

The values of employment at wage $w(p, z)$ for a worker currently with productivity z and a firm employing this worker are given by

$$W^E(p, z) = \gamma [w(p, z) + \beta[(1 - \delta)W^E(p, z) + \delta W^U(p, z)]] + (1 - \gamma) \mathbb{E}_z[W^E(p, z)], \quad (21)$$

$$J(p, z) = \gamma [y(p, z) - w(p, z) + \beta[(1 - \delta)J(p, z)]] + (1 - \gamma) \mathbb{E}_z[J(p, z)]. \quad (22)$$

The joint value of a match is then

$$M(p, z) = \gamma [y(p, z) + \beta[(1 - \delta)M(p, z) + \delta W^U(p, z)]] + (1 - \gamma) \mathbb{E}_z[M(p, z)]. \quad (23)$$

Proof of Lemma 2 We state the detailed version of this lemma as Lemma B.2. To simplify the analysis and without loss of generality, in what follows we let $\delta = 0$. Since we do not vary aggregate productivity to proof this lemma, we let $p = 1$ and leave it implicit in the analysis. To abbreviate notation defined $W^s \equiv W^U(z^s)$.

Lemma B.2: *The expected values of sampling, waiting, job surplus and unemployment, and the reallocation and separation reservation productivities, respond to changes in parameters as follows*

1. (i) $\frac{d(W^s - R)}{dc} > 0$, (ii) $\frac{d(M(z) - W^U(z))}{dc} > 0$ for all active labor markets; and (iii) $z^r - z^s$ is decreasing in c , strictly if $z^r > z^s$.
2. (i) $\frac{d(W^s - R)}{db} > 0$, (ii) $\frac{d(M(z) - W^U(z))}{db} < 0$ for all active labor markets; and (iii) $z^r - z^s$ is decreasing in b (while both z^r and z^s are increasing in b).
3. (i) $\frac{d(W^s - R)}{d\gamma} < 0$, (ii) there exists a cutoff $z^\gamma > \max\{z^r, z^s\}$ such that for all $z > z^\gamma$, $\frac{d(M(z) - W^U(z))}{d\gamma} > 0$ and $\frac{dW^U(z)}{d\gamma} > 0$; while $\frac{d(M(z) - W^U(z))}{d\gamma} < 0$ and $\frac{dW^U(z)}{d\gamma} < 0$ for $z^\gamma > z > \max\{z^r, z^s\}$. In expectation, $\frac{d(\mathbb{E}_z[M(z) - W^U(z)])}{d\gamma} > 0$ and $\frac{d\mathbb{E}_z[W^U(z)]}{d\gamma} > 0$. And (iii), if $z^r > z^s$ and $R - W^s$ is not too large, or if $z^s > z^r$, then $z^r - z^s$ is increasing in γ .

Proof. From (19) and (20) it follows that

$$(1 - \beta\gamma A(z^r))(W^s - R) = (1 - \beta\gamma)c - \beta\gamma \int_{z^r} \lambda(\theta(z))(1 - \eta)(M(z) - W^U(z))dF(z), \quad (24)$$

where $A(z^r) = F(z^r)$ if $z^r > z^s \geq \underline{z}$, and $A(z^r) = 1$ if $z^r \leq z^s$. The net gain of waiting instead of reallocating is that it saves the reallocation cost c , described in the first term on the RHS of (24). On the other hand, the second term on the RHS captures the opportunity cost incurred if the current z -productivity persists. In this case, the worker misses the opportunity to sample another z in a different occupation and start applying for jobs when his z -productivity in the new occupation is high enough.

We now consider the link between $W^s - R$ and $z^s - z^r$: the difference $W^s - R$ directly affects the distance between z^s and z^r . An increase in the former often leads directly to an increase in the latter. To see this formally, denote the parameter of interest generically by ω ; for example, c , b or γ . The reservation productivities for separation and reallocation then implicitly satisfy

$$M(\omega, z^s(\omega)) - W^s(\omega) = 0 \quad (25)$$

$$\lambda(\theta(\omega, z^r(\omega)))(1 - \eta)(M(\omega, z^r(\omega)) - W^s) + (W^s(\omega) - R(\omega)) = 0, \quad (26)$$

where (26) only applies when $R(\omega) > W^s(\omega)$ since with the assumed process for z we have that $W^s(\omega) > R(\omega)$ implies $z^r(\omega) = \underline{z}$.

To obtain the derivatives of $z^s(\omega)$ and $z^r(\omega)$ wrt ω , we can take the derivative of (25)-(26), where we make explicit the dependence on ω if and only if the derivative is taken with respect to it.

$$\begin{aligned} \frac{dz^s(\omega)}{d\omega} = & -\frac{d}{d\omega} \left[z^s - b + \beta(1 - \gamma)\mathbb{E}_z[\max\{M(\omega, z) - W(\omega, z), W^s(\omega) - R(\omega)\}] \right. \\ & \left. + \beta\gamma(W^s - R) \right] - \beta\gamma \frac{d(W^s(\omega) - R(\omega))}{d\omega} \end{aligned} \quad (27)$$

$$\begin{aligned} \frac{dz^r(\omega)}{d\omega} = & -\frac{d}{d\omega} \left[z^r - b + \beta(1 - \gamma)\mathbb{E}_z[\max\{M(\omega, z) - W(\omega, z), W^s(\omega) - R(\omega)\}] \right. \\ & \left. + \beta\gamma(1 - \lambda(\theta)(1 - \eta))(M(z^r) - W^s) \right] - \frac{1 - \beta\gamma(1 - \lambda(\theta))}{\lambda(\theta)} \frac{d(W^s(\omega) - R(\omega))}{d\omega}. \end{aligned} \quad (28)$$

These equations imply that the sign of the derivative of $z^r - z^s$ with respect to b or c is the opposite of the sign of the corresponding derivatives of $W^s - R$. This is because $\beta\gamma < \frac{1 - \beta\gamma(1 - \lambda(\theta))}{\lambda(\theta)}$ and, when taking derivatives, the differential terms within the squared brackets are identical.

We divide the proof into three sections. To simplify notation we consider the transformation $y = y(z)$, where $y(\cdot)$ is the common production function, and let F_y denote the cdf of y . Accordingly, let $y^r = y(z^r)$ and $y^s = y(z^s)$.

Comparative statics wrt c Consider the difference $W^s - R$ and values of c such that $R \geq W^s$. In this case we have that

$$\begin{aligned} W^s &= (1 - \gamma)(R + c) + \gamma(b + \beta R), \\ W^s - R &= -\gamma(1 - \beta)R + (1 - \gamma)c + \gamma b. \end{aligned}$$

Suppose towards a contradiction that $d(W^s - R)/dc < 0$. The above equations imply that $\frac{dR}{dc} > \frac{(1-\gamma)}{\gamma(1-\beta)} > 0$. We will proceed by showing that under $d(W^s - R)/dc < 0$ both the expected surplus (after a z -shock) and the surplus for active labor markets (those with productivities that entail positive match surplus) decrease, which implies that the value of unemployment decreases, which in turn implies $\frac{dR}{dc} < 0$, which is our contradiction.

Consider an active labor market with $W^U(y) > R$, the surplus on this labor market is given by

$$\begin{aligned} M(y) - W^U(y) &= \gamma(y - b + \beta(1 - \lambda(\theta(y))(1 - \eta))(M(y) - W^U(y))) \\ &\quad + (1 - \gamma)(\mathbb{E}_y[M(y) - W^U(y)] + (y - \mathbb{E}[y])), \end{aligned} \quad (29)$$

where $\mathbb{E}_y[M(y) - W^U(y)]$ describes the expected surplus after a z -shock (after the search stage). Note that $\frac{d}{d(M(y) - W^U(y))}(\lambda(\theta(y))(1 - \eta)(M(y) - W^U(y))) = \lambda(\theta(y))$, since (dropping the y argument for brevity) $(1 - \eta)(M - W^U) = \frac{(1-\eta)}{\eta} J = \frac{1-\eta}{\eta} \frac{k}{q(\theta)}$, and hence $\lambda(\theta)(1 - \eta)(M - W^U) = \frac{1-\eta}{\eta} k\theta$. Moreover, $\frac{d\theta}{d(M - W^U)} = \frac{\eta}{1-\eta} \frac{\lambda(\theta)}{k}$. Putting the last two expressions together, we find that the above derivative equals $\lambda(\theta)$. From (29), it follows that

$$0 < \frac{d(M - W^U)}{d(\mathbb{E}_y[M(y) - W^U(y)])} = \frac{1 - \gamma}{1 - \gamma\beta(1 - \lambda(\theta))} < 1. \quad (30)$$

Expected match surplus measured after the search stage is

$$\begin{aligned} \mathbb{E}_y[M(y) - W^U(y)] &= \int_{y^r} y - b + \beta(1 - \lambda(\theta(y))(1 - \eta))(M(y) - W^U(y)) dF_y(y) \\ &\quad + \int_{y^s}^{y^r} y - b + \beta(M(y) - R) dF_y(y) + \int_{y^s} y - b + \beta(W^s - R) dF_y(y), \end{aligned} \quad (31)$$

note that the $(1 - \gamma)$ shock integrates out. The third term of the expression above is decreasing in c , by our contradiction supposition. The second term, $\int_{y^s}^{y^r} [M(y) - W^U(y)] dF_y(y)$, can be rewritten as

$$M - W^s = \gamma(y - b + \beta(M - W^s + W^s - R)) + (1 - \gamma)(\mathbb{E}_y[M(y) - W^U(y)] + y - \mathbb{E}[y]),$$

and rearranging yields

$$M - W^s = \frac{\gamma}{1 - \gamma\beta}(y - b + \beta(W^s - R)) + \frac{1 - \gamma}{1 - \gamma\beta} \mathbb{E}_y[M(y) - W^U(y)],$$

where $\frac{\gamma}{1 - \gamma\beta}(y - b + \beta(W^s - R))$ is decreasing. For the first term, note that $M(y) - W^U(y)$ responds

to c through $\mathbb{E}_y[M(y) - W^U(y)]$, from (30). Combining all the elements (30), (31) and the last two equations, we find that

$$\begin{aligned} \frac{d\mathbb{E}_y[M(y) - W^U(y)]}{dc} &= \int_{y^r} \frac{(1-\gamma)\beta(1-\lambda(\theta(y)))}{1-\gamma\beta(1-\lambda(\theta))} dF_y(y) \frac{d\mathbb{E}_y[M(y) - W^U(y)]}{dc} \\ &\quad + (F_y(y^r) - F_y(y^s)) \left(\frac{\gamma\beta}{1-\gamma\beta} \frac{d(W^s - R)}{dc} + \frac{1-\gamma}{1-\gamma\beta} \frac{d\mathbb{E}_y[M(y) - W^U(y)]}{dc} \right) \\ &\quad + F_y(y^s)\beta \frac{d(W^s - R)}{dc} \\ \Leftrightarrow \frac{d\mathbb{E}_y[M(y) - W^U(y)]}{dc} &= C \cdot \frac{d(W^s - R)}{dc} < 0, \end{aligned} \quad (32)$$

where C is a positive constant. From this it follows that $\frac{d[M(y)-W^U(y)]}{dc} < 0$, by (30).

Next consider $\frac{dW^U}{dc}$, and $\frac{d\mathbb{E}[W^U]}{dc}$. For $y \leq y^r$, $W^U(y) = W^s = (1-\gamma)\mathbb{E}[W^U] + \gamma(b + \beta\mathbb{E}[W^U] - \beta c)$. For $y > y^r$, $W^U(y) = (1-\gamma)\mathbb{E}[W^U] + \gamma(b + \beta(\lambda(\theta(y))(1-\eta)(M(y) - W^U(y)) + \beta W^U(y)))$. It follows that $\mathbb{E}[W^U] = F_y(y^r)(b + \beta\mathbb{E}[W^U] - \beta c) + \int_{y^r} (b + \beta\lambda(\theta(y))(1-\eta)(M(y) - W^U(y)) + \beta W^U(y)) dF_y(y)$. Combining the latter equation with

$$W^U = \frac{1-\gamma}{1-\beta\gamma} \mathbb{E}[W^U] + \frac{\gamma}{1-\beta\gamma} (b + \beta\lambda(\theta(y))(1-\eta)(M(y) - W^U(y))),$$

we have that

$$\begin{aligned} &\left(1 - \beta F_y(y^r) - \beta \frac{1-\gamma}{1-\beta\gamma} (1 - F_y(y^r)) \right) \mathbb{E}[W^U] \\ &= F_y(y^r)(b - \beta c) + \int_{y^r} \frac{b + \beta\lambda(\theta(y))(1-\eta)(M(y) - W^U(y))}{1-\beta\gamma} dF_y(y) \end{aligned}$$

Taking the derivative with respect to c , we find that both the first and second terms on the RHS are negative, the latter because we have established that $\frac{d(M(y)-W^U(y))}{dc} < 0$. It then follows that $\frac{d\mathbb{E}[W^U]}{dc} < 0$, which implies that $\frac{dR}{dc} = \frac{d\mathbb{E}[W^U]}{dc} - 1 < 0$, which contradicts our premise.

Now consider values of c such that $R < W^s$. Here there is rest unemployment. In this case, $W^s = \gamma(b + \beta W^s) + (1-\gamma)\mathbb{E}[W^U]$ and $\frac{dW^s}{dc} = 0$, since workers with productivities $y \leq y^s$ will never reallocate. Doing so implies paying a cost $c > 0$ and randomly drawing a new productivity, while by not sampling a worker obtains (with probability $1-\gamma$) a free draw from the productivity distribution. Hence, $d(R - W^s)/dc = dR/dc$. Noting that workers with $y > y^s$ prefer employment in their current occupation, the above arguments imply W^U is independent of the value of sampling for any y . It then follows that $\frac{dR}{dc} = \frac{d\mathbb{E}[W^U]}{dc} - 1 = -1 < 0$, which contradicts our premise.

Comparative Statics with respect to b . Here we proceed in the same way as in the previous case. Once again consider the difference $W^s - R$ such that $R \geq W^s$. Writing W^s and W^U , for

productivities above the separation cutoff, as

$$W^s = (1 - \gamma)\mathbb{E}[W^U] + \gamma(b + \beta(R - W^s)) + \gamma\beta W^s \quad (33)$$

$$W^U(y) = (1 - \gamma)\mathbb{E}[W^U] + \gamma(b + \beta(\lambda(\theta)(1 - \eta)(M(y) - W^U(y))) + \gamma\beta W^U(y), \quad (34)$$

we find that $W^s - \mathbb{E}[W^U] = \int_{y^r} (W^s - W^U(y))dF_y(y)$, which in turn implies

$$W^s - R = \frac{1}{1 - \gamma\beta F_y(y^r)} \left(-\beta\gamma \int_{y^r} \lambda(\theta)(1 - \eta)(M(y) - W^U(y))dF_y(y) + (1 - \gamma\beta)c \right). \quad (35)$$

That is, the difference between waiting one period to sample and sampling a new productivity now is the forgone possibility of searching for a job in the new occupation next period, but on the other hand, the sampling cost only has to be incurred next period with probability γ , and discounted at rate β .

Next consider the relationship between $M(y) - W^U(y)$ and $\mathbb{E}[M(y) - W^U(y)]$. From (29) and (30), we find that

$$\frac{d(M(y) - W^U(y))}{db} = \frac{1 - \gamma}{1 - \gamma\beta(1 - \lambda(\theta))} \frac{d\mathbb{E}[M(y) - W^U(y)]}{db} - \frac{\gamma}{1 - \gamma\beta(1 - \lambda(\theta))}. \quad (36)$$

Note that $\frac{d(M(y) - W^U(y))}{db}$ must have the same sign for all y , which is positive if and only if

$$\frac{d\mathbb{E}[M(y) - W^U(y)]}{db} > \frac{\gamma}{1 - \gamma}.$$

Towards a contradiction, suppose $\frac{d(W^s - R)}{db} < 0$. Then, we have $\frac{d(W^s - R)}{db} = \frac{d(W^s - \mathbb{E}[W^U])}{db}$, which equals $\frac{d}{db} \left(- \int_{y^r} \max\{W^U(y) - W^s, 0\}dF_y(y) \right)$. By the envelope condition, the effect $\frac{dy^r}{db}$ disappears. By the previous argument and (33) subtracted by (34), it follows that $\frac{d(M(y) - W^U(y))}{db} > 0$ and by (36), $\frac{d\mathbb{E}[M(y) - W^U(y)]}{db} > 0$.

Along the lines of (32), we find

$$\begin{aligned} \frac{d\mathbb{E}_y[M(y) - W^U(y)]}{db} &= -1 + \int_{y^r} \frac{\beta(1 - \lambda(\theta(y))) - \gamma\beta(1 - \lambda(\theta))}{1 - \gamma\beta(1 - \lambda(\theta))} dF_y(y) \frac{d\mathbb{E}_y[M(y) - W^U(y)]}{db} \\ &\quad - \int_{y^r} \frac{\gamma\beta(1 - \lambda(\theta(y)))}{1 - \gamma\beta(1 - \lambda(\theta))} dF_y(y) \frac{d\mathbb{E}_y[M(y) - W^U(y)]}{db} \\ &\quad + (F_y(y^r) - F_y(y^s)) \left(\frac{\gamma\beta^2}{1 - \gamma\beta} \frac{d(W^s - R)}{db} + \frac{\beta(1 - \gamma)}{1 - \gamma\beta} \frac{d\mathbb{E}_y[M(y) - W^U(y)]}{db} \right) \\ &\quad - (F_y(y^r) - F_y(y^s)) \frac{\gamma\beta}{1 - \gamma\beta} + F_y(y^s)\beta \frac{d(W^s - R)}{db} \quad (37) \\ \implies \frac{d\mathbb{E}_y[M(y) - W^U(y)]}{db} &= C_2 \cdot \frac{d(W^s - R)}{db} - C_3 < 0, \end{aligned}$$

with C_2, C_3 are positive-valued terms. This is the desired contradiction.

Next consider the case that $W^s > R$. Then, equation (35) becomes instead

$$W^s - \mathbb{E}[W^U] = -\frac{\beta\gamma}{1 - \beta\gamma} \int_{y^s} \lambda(\theta)(1 - \eta)(M(y) - W^U(y))dF_y(y) \quad (38)$$

Similarly, if we start from the premise that $\frac{d(W^s - R)}{db} < 0$, this will imply again by (36) that $\frac{d\mathbb{E}_y[M(y) - W^U(y)]}{db} > 0$. Note that in this case, in equation (31) reduces to

$$\mathbb{E}_y[M(y) - W^U(y)] = \int_{y^s} y - b + \beta\lambda(\theta(y))(1 - \eta)(M(y) - W^U(y))dF_y(y), \quad (39)$$

and (37) reduces to

$$\begin{aligned} \frac{d\mathbb{E}_y[M(y) - W^U(y)]}{db} = & -1 + \int_{y^s} \frac{\beta(1 - \lambda(\theta(y))) - \gamma\beta(1 - \lambda(\theta(y)))}{1 - \gamma\beta(1 - \lambda(\theta))} dF_y(y) \frac{d\mathbb{E}_y[M(y) - W^U(y)]}{db} \\ & - \int_{y^s} \frac{\gamma\beta(1 - \lambda(\theta(y)))}{1 - \gamma\beta(1 - \lambda(\theta))} dF_y(y) \frac{d\mathbb{E}_y[M(y) - W^U(y)]}{db}, \end{aligned} \quad (40)$$

which again implies that $\frac{d\mathbb{E}[M - W^U]}{db} < 0$, a contradiction.

Comparative statics with respect to γ As in the previous cases we start with the case where $R > W^s$. Towards a contradiction, assume that $\frac{d(W^s - R)}{d\gamma} > 0$. From equation (35), we find that

$$\begin{aligned} \frac{d(W^s - R)}{d\gamma} = & \frac{\beta F_y(y^r)}{1 - \beta\gamma} (W^s - R) + \frac{1}{1 - \beta\gamma F_y(y^r)} \left(- \int_{y^r} \lambda(\theta)(1 - \eta)(M(y) - W^U(y))dF_y(y) - \beta c \right) \\ & - \int_{y^r} \beta\gamma\lambda(\theta) \frac{d(M(y) - W^U(y))}{d\gamma} dF_y(y) \end{aligned} \quad (41)$$

From our premise it follows that

$$\begin{aligned} - \int_{y^r} \beta\gamma\lambda(\theta) \frac{d(M(y) - W^U(y))}{d\gamma} dF_y(y) \geq & \frac{\beta F_y(y^r)}{1 - \beta\gamma} (R - W^s) \\ + \frac{1}{1 - \beta\gamma F_y(y^r)} \left(\int_{y^r} \lambda(\theta)(1 - \eta)(M(y) - W^U(y))dF_y(y) + \beta c \right) > & 0 \end{aligned} \quad (42)$$

Now, let us look at the implications for $\frac{d\mathbb{E}[M(y) - W^U(y)]}{d\gamma}$. We can rewrite (31), bringing tomorrow's continuation values to the LHS as

$$\begin{aligned} (1 - \beta)\mathbb{E}_y[M(y) - W^U(y)] = & \int_{y^r} y - b - \beta\lambda(\theta(y))(1 - \eta)(M(y) - W^U(y))dF_y(y) \\ & + \int_{y^s}^{y^r} y - b + \beta(W^s - R)dF_y(y) \\ & + \int_{y^s} y - b + \beta(W^s - R) - \beta(M(y) - W^s)dF_y(y) \end{aligned} \quad (43)$$

Taking derivatives with respect to γ , we find

$$\begin{aligned}
(1 - \beta) \frac{d\mathbb{E}_y[M(y) - W^U(y)]}{d\gamma} &= -\beta \int_{y^r}^y \lambda(\theta(y)) \frac{d(M(y) - W^U(y))}{d\gamma} dF_y(y) \\
&+ \int_{y^s}^{y^r} \beta \frac{d(W^s - R)}{d\gamma} dF_y(y) \\
&+ \int_{y^s}^{y^r} \beta \frac{d(W^s - R)}{d\gamma} - \beta \frac{d(M(y) - W^s)}{d\gamma} dF_y(y) \quad (44) \\
&> 0
\end{aligned}$$

For $y < y^s$ it holds that

$$\begin{aligned}
\frac{d(M(y) - W^s)}{d\gamma} &= (1 - \gamma) \frac{d\mathbb{E}[M(y) - W^U(y)]}{d\gamma} + \gamma \beta \frac{d(W^s - R)}{d\gamma} \\
&+ (y - b + \beta(W^s - R) - \mathbb{E}[M(y) - W^U(y)]). \quad (45)
\end{aligned}$$

The first two terms on the RHS are positive, the last term on the RHS negative. In the RHS of (44) all terms are positive, except for $F_y(y^s)(1 - \gamma) \frac{d\mathbb{E}[M(y) - W^U(y)]}{d\gamma}$ and $F_y(y^s)\gamma\beta \frac{d(W^s - R)}{d\gamma}$ associated with $\frac{d(M(y) - W^s)}{d\gamma}$. However, one can see that $-F_y(y^s)\gamma\beta \frac{d(W^s - R)}{d\gamma}$ is more than offset by $\beta \frac{d(W^s - R)}{d\gamma}$ on the same line, while we can bring $F_y(y^s)(1 - \gamma) \frac{d\mathbb{E}[M(y) - W^U(y)]}{d\gamma}$ to the LHS, to find that $\frac{d\mathbb{E}[M(y) - W^U(y)]}{d\gamma}$ is premultiplied by $(1 - F_y(y^s)\beta\gamma) > 0$. Hence, it follows that $\frac{d\mathbb{E}[M(y) - W^U(y)]}{d\gamma} > 0$.

From $M(y) - W^U(y) = (1 - \gamma)\mathbb{E}[M(y) - W^U(y)] + \gamma(y - b + \beta(1 - \lambda(\theta)(1 - \eta))(M(y) - W^U(y))$, it follows that for $y > y^r$

$$\begin{aligned}
\beta\gamma\lambda(\theta) \frac{dM(y) - W^U(y)}{d\gamma} &= \frac{\beta\gamma\lambda(\theta)}{1 - \beta\gamma(1 - \lambda(\theta))} \left((y - b + \beta(1 - \lambda(\theta)(1 - \eta))(M(y) - W^U(y)) \right. \\
&\quad \left. - \mathbb{E}[M(y) - W^U(y)] \right) + (1 - \gamma) \frac{d\mathbb{E}[M(y) - W^U(y)]}{d\gamma} \quad (46)
\end{aligned}$$

Integrating this term over all $y > y^r$, we have

$$\begin{aligned}
\beta\gamma \int_{y^r}^y \lambda(\theta(y)) \frac{d(M(y) - W^U(y))}{d\gamma} dF_y(y) &\geq \frac{\beta\gamma\lambda(\theta(y^r))}{1 - \beta\gamma + \beta\gamma\lambda(\theta(y^r))} \left(\int_{y^r}^y (1 - \gamma) \frac{d\mathbb{E}[M(y) - W^U(y)]}{d\gamma} dF_y(y) \right. \\
&\quad \left. + \frac{1}{\gamma} \int_{y^r}^y M(y) - W^U(y) - \mathbb{E}[M(y) - W^U(y)] dF_y(y) \right) > 0, \quad (47)
\end{aligned}$$

where the last inequality follows from the fact that $M(y) - W^U(y) - \mathbb{E}[M(y) - W^U(y)]$ is increasing in y , and $\frac{\beta\lambda(\theta(y))}{1 - \beta\gamma + \beta\gamma\lambda(\theta(y))}$ similarly is increasing in y . Then $\int_{y^r}^y M(y) - W^U(y) - \mathbb{E}[M(y) - W^U(y)] dF_y(y)$ is larger than zero. The LHS of (47) is positive, but this contradicts our premise in (42).

For the case that $W^s > R$, we can derive directly that

$$(1 - \beta) \frac{d\mathbb{E}_y[M(y) - W^U(y)]}{d\gamma} = -\beta \int_{y^r} \lambda(\theta(y)) \frac{d(M(y) - W^U(y))}{d\gamma} dF_y(y); \quad (48)$$

with this in hand, we can derive from (46) that

$$-(1 - \beta) \frac{d\mathbb{E}_y[M(y) - W^U(y)]}{d\gamma} = \int_{y^s} \left(\frac{\beta\gamma\lambda(\theta)}{1 - \beta\gamma(1 - \lambda(\theta))} \left((y - b + \beta(1 - \lambda(\theta)(1 - \eta))(M(y) - W^U(y)) - \mathbb{E}[M(y) - W^U(y)]) + (1 - \gamma) \frac{d\mathbb{E}[M(y) - W^U(y)]}{d\gamma} \right) \right) dF_y(y). \quad (49)$$

Isolating $\frac{d\mathbb{E}[M(y) - W^U(y)]}{d\gamma}$ on the LHS, we find

$$\begin{aligned} \frac{d\mathbb{E}_y[M(y) - W^U(y)]}{d\gamma} \left((1 - \beta) + \frac{F_y(y^s)\beta\gamma\lambda(\theta)(1 - \gamma)}{1 - \beta\gamma + \beta\gamma\lambda(\theta)} \right) = \\ - \int_{y^s} \left(\frac{\beta\gamma\lambda(\theta)}{1 - \beta\gamma(1 - \lambda(\theta))} (y - b + \beta(1 - \lambda(\theta)(1 - \eta))(M(y) - W^U(y)) - \mathbb{E}[M(y) - W^U(y)]) \right) dF_y(y) < 0. \end{aligned} \quad (50)$$

From (50), it follows that $\frac{d\mathbb{E}_y[M(y) - W^U(y)]}{d\gamma} < 0$, and therefore that, from (24) - for the case in which $W^s > R$ -, the above equation, and equation (48), $W^s - R$ is decreasing in γ :

$$\frac{d(W^s - R)}{d\gamma} = \frac{d(W^s - \mathbb{E}[W^U])}{d\gamma} = -\frac{1}{1 - \beta} \int_{y^s} \gamma\lambda \frac{d(M(y) - W^U(y))}{d\gamma} < 0. \quad (51)$$

This complete the proof for Lemma B.1. \square

Proof of Lemma 3 Using the same setting as in Lemma B.1 we now introduce human capital x , assuming it enters in a multiplicative way in the production function. Keeping the same notation as in Lemma B.1, let $p = 1$ such that $y = y(z)$ and total output is given by yx . As before, let F_y denote the cdf of y . Normalize (without a loss of generality, for the results we are deriving here) $x = 1$. If we have an incremental improvement in x that is occupational specific, the value of sampling will stay constant, at $R = \mathbb{E}_y[W^U(1, y)] - c$, where now we denote $W^U(x, y)$ by the productivity component that is enjoyed by every worker on the same labor market. However, the value of $W^s(x)$ increases, since $W^s(x) = (1 - \gamma)\mathbb{E}[W^U(x, y)] + \gamma(b + \beta \max\{R, W^s(x)\})$ implies that $W^s(x)$ is increasing in $\mathbb{E}[W^U(x, y)]$.

Suppose that $R > W^s(x)$. The value of unemployment for the cases in which $y \geq y^r(x)$ and $y^r > y \geq y^s$ is given by

$$\begin{aligned} W^U(x, y) &= (1 - \gamma)\mathbb{E}_y[W^U(x, y)] + \gamma(b + \beta\lambda(\theta)(1 - \eta)(M(x, y) - W^U(x, y)) + \beta W^U(x, y)) \\ W^s(x) &= (1 - \gamma)\mathbb{E}_y[W^U(x, y)] + \gamma(b + \beta R). \end{aligned}$$

When comparing the expected value of separating with the expected value of sampling (and hence, a reset to $x = 1$), we see that the difference $W^s(x) - \mathbb{E}_y[W^U(1, y)]$ is given by

$$(W^s(x) - \mathbb{E}_y[W^U(1, y)]) = (1 - \gamma)(\mathbb{E}_y[W^U(x, y)] + C,$$

where C denotes those terms that do not depend on x . As a result, $\frac{d(W^s(x) - \mathbb{E}_y[W^U(1, y)])}{dx} = (1 - \gamma)\frac{d\mathbb{E}_y[W^U(x, y)]}{dx}$. Rewriting $\mathbb{E}[W^U(x, y)]$, using $W^U(x, y) = (1 - \gamma)\mathbb{E}[W^U(x, y)] + \gamma(b + \beta(\lambda(\theta)(1 - \eta)(M(x, y) - W^U(x, y)) + \beta W^U(x, y))$ we find

$$\mathbb{E}[W^U(x, y)] = (1 - F_y(y^r(x))(b + \beta R) + \int_{y^r} \left[b + \beta\lambda(\theta)(M(x, y) - W^U(x, y)) + \beta W^U(x, y) \right] dF_y(y),$$

from which it follows that

$$\begin{aligned} \mathbb{E}[W^U(x, y)] \left(1 - \frac{\beta(1 - \gamma)}{1 - \beta\gamma} (1 - F_y(y^r(x))) \right) = & \quad (52) \\ F_y(y^r(x))(b + \beta R) + \frac{\beta\gamma}{1 - \beta\gamma} b(1 - F_y(y^r(x))) + \frac{\beta}{1 - \beta\gamma} \int_{y^r(x)} \left[\lambda(\theta(x, y))(1 - \eta)(M(x, y) - W^U(x, y)) \right] dF_y(y). \end{aligned}$$

In turn, (using the envelope condition, which implies that the term premultiplying $dy^r(x)/dx$ again equals zero), this means

$$\begin{aligned} \frac{d\mathbb{E}_y[W^U(x, y)]}{dx} = & \quad (53) \\ \frac{\beta}{(1 - \beta\gamma) - \beta(1 - \gamma)(1 - F_y(y^r(x)))} \frac{d}{dx} \left(\int_{y^r} \left[\lambda(\theta(x, y))(1 - \eta)(M(x, y) - W^U(x, y)) \right] dF_y(y) \right). \end{aligned}$$

Let us now look at the behavior of the expected surplus, from

$$\begin{aligned} \mathbb{E}_y[M(x, y) - W^U(x, y)] = \int_{\underline{y}}^{\bar{y}} (yx - b) dF_y(y) + \int_{y^r(x)} \beta\lambda(\theta(x, y))(1 - \eta)(M(x, y) - W^U(x, y)) dF_y(y) \\ + \int_{y^s(x)}^{y^r(x)} \beta(M(x, y) - W^s(x)) dF_y(y) + \beta \int_{y^s(x)}^{y^r(x)} (W^s(x) - R) dF_y(y). \end{aligned} \quad (54)$$

The surplus for labor markets with $y \geq y^r(x)$ and $y^r > y \geq y^s$, respectively, behaves as

$$\begin{aligned} \frac{d(M(x, y) - W^U(x, y))}{dx} = (1 - \gamma) \frac{d\mathbb{E}_y[M(x, y) - W^U(x, y)]}{dx} + (1 - \gamma)(y - \mathbb{E}[y]) + \gamma y \\ + \beta\gamma(1 - \lambda(\theta(x, y))) \frac{d(M(x, y) - W^U(x, y))}{dx} \end{aligned} \quad (55)$$

$$\begin{aligned} \frac{d(M(x, y) - W^s(x))}{dx} = (1 - \gamma) \frac{d\mathbb{E}_y[M(x, y) - W^U(x, y)]}{dx} + (1 - \gamma)(y - \mathbb{E}[y]) + \gamma y \\ + \beta\gamma \frac{d(M(x, y) - W^s(x))}{dx} + \beta\gamma \frac{d(W^s(x) - R)}{dx}. \end{aligned} \quad (56)$$

The derivative of $\int_{y^r} \beta \lambda(\theta(x, y))(1 - \eta)(M(x, y) - W^U(x, y))dF_y(y)$ wrt to x then equals

$$\int_{y^r} \left(\frac{\beta \lambda(\theta(x, y))(1 - \gamma)}{1 - \beta \gamma(1 - \lambda(\theta(x, y)))} \left(\frac{d\mathbb{E}_y[M(x, y) - W^U(x, y)]}{dx} + y - \mathbb{E}[y] \right) + \frac{\beta \lambda(\theta(x, y))\gamma}{1 - \beta \gamma(1 - \lambda(\theta(x, y)))} y \right) dF_y(y), \quad (57)$$

where we note that $\int_{y^r} \frac{\beta \lambda(\theta(x, y))(1 - \gamma)}{1 - \beta \gamma(1 - \lambda(\theta(x, y)))} dF_y(y) \leq \frac{\beta \lambda(\theta(x, \bar{y}))(1 - \gamma)}{1 - \beta \gamma(1 - \lambda(\theta(x, \bar{y})))} (1 - F_y(y^r)) < 1 - F_y(y^r)$.

We now consider the behavior of the second line in (54). The derivative of $\beta(W^s(x) - R)$ is given by

$$\frac{\beta(1 - \gamma)}{1 - \beta + \beta(1 - \gamma)F_y(y^r(x))} \times \int_{y^r} \left(\frac{\beta \lambda(\theta(x, y))(1 - \gamma)}{1 - \beta \gamma(1 - \lambda(\theta(x, y)))} \left(\frac{d\mathbb{E}_y[M(x, y) - W^U(x, y)]}{dx} + y - \mathbb{E}[y] \right) + \frac{\beta \lambda(\theta(x, y))\gamma}{1 - \beta \gamma(1 - \lambda(\theta(x, y)))} y \right) dF_y(y). \quad (58)$$

The derivative of $\beta(M(x, y) - W^U(x, y)) + \beta(W^s(x) - R)$ with respect to x is then

$$\frac{\beta(1 - \gamma)}{1 - \beta \gamma} \left(\frac{d\mathbb{E}_y[M(x, y) - W^U(x, y)]}{dx} + y - \mathbb{E}[y] \right) + \frac{\beta \gamma}{1 - \beta \gamma} y + \left(\frac{1}{1 - \beta \gamma} \frac{\beta(1 - \gamma)}{1 - \beta + \beta(1 - \gamma)F_y(y^r)} \int_{y^r} \left(\frac{\beta \lambda(\theta(x, y))(1 - \gamma)}{1 - \beta \gamma(1 - \lambda(\theta(x, y)))} \left(\frac{d\mathbb{E}_y[M(x, y) - W^U(x, y)]}{dx} + y - \mathbb{E}[y] \right) + \frac{\beta \lambda(\theta(x, y))\gamma}{1 - \beta \gamma(1 - \lambda(\theta(x, y)))} y \right) dF_y(y) \right). \quad (59)$$

We want to make sure that all terms premultiplying $\frac{d\mathbb{E}_y[M(x, y) - W^U(x, y)]}{dx} + y - \mathbb{E}[y]$ on the RHS do not add up to a number larger than 1. First, note that the terms premultiplying the derivative of the expected surplus in (59) are larger than in (58). Hence if we can show that by replacing the premultiplication term in (58) with the corresponding term in (59), we obtain that the entire term premultiplying the derivative of the expected surplus on the RHS is less than one, we have established this step of the proof. The contribution of these premultiplication terms in the second term on the RHS of (54) is smaller than $\beta(1 - \gamma)(1 - F_y(y^r(x)))$. Hence, if

$$\left(\beta \frac{d(M(x, y) - W^U(x, y))}{dx} + \beta \frac{d(M(x, y) - W^U(x, y))}{dx} \right) F_y(y^r(x)) < 1 - \beta(1 - \gamma)(1 - F_y(y^r(x))) \quad (60)$$

we have established the desired property. Starting from collecting the terms premultiplying the derivative of the expected surplus, $\frac{d\mathbb{E}_y[M(x, y) - W^U(x, y)]}{dx} + y - \mathbb{E}[y]$, and substituting these into the LHS of (60), we can develop

$$\begin{aligned} & F_y(y^r) \left(\frac{\beta(1 - \gamma)(1 - \beta + \beta(1 - \gamma)F_y(y^r(x)))}{(1 - \gamma\beta)(1 - \beta + \beta(1 - \gamma)F_y(y^r(x)))} + \frac{\beta(1 - \gamma)(\beta(1 - \gamma)(1 - F_y(y^r(x))))}{(1 - \gamma\beta)(1 - \beta + \beta(1 - \gamma)F_y(y^r(x)))} \right) \\ &= \frac{\beta(1 - \gamma)(1 - \beta + \beta(1 - \gamma))}{(1 - \gamma\beta)(1 - \beta + \beta(1 - \gamma)F_y(y^r(x)))} F_y(y^r(x)) \end{aligned} \quad (61)$$

The RHS of (60) can be rewritten as $1 - \beta + \beta\gamma + \beta(1 - \gamma)F_y(y^r(x))$. We will show that $\beta\gamma +$

$\beta(1-\gamma)F_y(y^r(x))$ is larger than (61), from which the desired result follows (as the remaining term, $1-\beta$, is larger than zero, and therefore means that the desired inequality is additionally slack).

$$\beta\gamma > \frac{\beta\gamma(\beta(1-\gamma))(1-\beta+\beta(1-\gamma))F_y(y^r(x))}{(1-\gamma\beta)(1-\beta+\beta(1-\gamma))F_y(y^r(x))} \quad (62)$$

$$\beta(1-\gamma)F_y(y^r(x)) > \frac{\beta(1-\gamma)(1-\gamma\beta)(1-\beta+\beta(1-\gamma))F_y(y^r(x))}{(1-\gamma\beta)(1-\beta+\beta F_y(y^r(x)))} \quad (63)$$

Adding up (62) and (63), we find that the RHS equals precisely the term in (61).

Bringing all terms involving $\frac{d\mathbb{E}_y[M(x,y)-W^U(x,y)]}{dx} + y - \mathbb{E}[y]$, it is now straightforward to see that the remaining terms on the RHS premultiplying y , are positive. (Integrating terms $y - \mathbb{E}[y]$, will also yield a positive term.) Hence, $\frac{d\mathbb{E}_y[M(x,y)-W^U(x,y)]}{dx} > 0$. It follows from (55) that $\frac{d(M(x,y)-W^U(x,y))}{dx} > 0$, and therefore, by (53), $\frac{d\mathbb{E}_y[W^U(x,y)]}{dx} > 0$, and subsequently, $\frac{d(W^s(x)-R)}{dx} > 0$.

Consider next the case that $W^s(x) > R$. In this case again $\frac{d(R-W^s(x))}{dx} = (1-\gamma)\frac{d\mathbb{E}_y[W^U(x,y)]}{dx}$. In this case

$$(1-\beta)\frac{d\mathbb{E}_y[W^U(x,y)]}{dx} = \int_{y^s(x)} \beta\lambda(\theta(x,y))\frac{d(M(x,y)-W^U(x,y))}{dx}dF_y(y) \quad (64)$$

The surplus $M(x,y) - W^U(x,y)$ responds to changes in x is given by

$$\begin{aligned} \frac{d(M(x,y)-W^U(x,y))}{dx} &= (1-\gamma)\frac{d\mathbb{E}_y[M(x,y)-W^U(x,y)]}{dx} + (1-\gamma)(\mathbb{E}_y[y]-y) \\ &\quad + \gamma(y+\beta(1-\lambda(x,y)))\left(\frac{d(M(x,y)-W^U(x,y))}{dx}\right), \end{aligned} \quad (65)$$

while the expected surplus evolves according to

$$\frac{d\mathbb{E}_y[M(x,y)-W^U(x,y)]}{dx} = \int_{y^s(x)} y + \beta(1-\lambda(x,y))\frac{d(M(x,y)-W^U(x,y))}{dx}, \quad (66)$$

Substituting (65) into (66), it follows that $\frac{d\mathbb{E}_y[M(x,y)-W^U(x,y)]}{dx} > 0$, from which in turn it follows that (64) is also positive.

Finally, let us look at the implications for the cutoff in terms of productivities $y^s(x), y^r(x)$. Consider first the case that $y^r(x) > y^s(x)$. The reservation quality for separation and reallocation satisfy implicitly, respectively

$$M(x, y^s(x)) - W^s(x) = 0 \quad (67)$$

$$\lambda(\theta(x, y^r(x)))(1-\eta)(M(x, y^r(x)) - W^U(x, y^r(x))) + (W^s(x) - R) = 0. \quad (68)$$

We can see this defines $y^r(x), y^s(x)$ as implicit functions of $M(x,y) - W^s(x)$ and $W^s(x) - R$.

The first term is given by

$$M(x, y^s(x)) - W^s(x) = xy^s(x) - b + \beta(1 - \gamma)\mathbb{E}_y[\max\{M(x, y) - W^U(x, y), W^s(x) - R\}] + \beta\gamma(W^s(x) - R) \quad (69)$$

$$M(x, y^r(x)) - W^s(x) = xy^r(x) - b + \beta(1 - \gamma)\mathbb{E}_y[\max\{M(x, y) - W^U(x, y), W^s - R\}] + \beta\gamma(1 - \lambda(\theta(x, y^r(x)))(1 - \eta)(M(x, y^r(x)) - W^s(x)). \quad (70)$$

Taking derivatives with respect to x (taking into account the implicit relationship $y^s(x), y^r(x)$), we find

$$y^s(x) + \beta(1 - \gamma)\frac{d}{dx}\left(\mathbb{E}_y[\max\{M(x, y) - W^U(x, y), W^s(x) - R\}]\right) + \beta\gamma\frac{d(W^s(x) - R)}{dx} + x\frac{dy^s(x)}{dx} = 0 \quad (71)$$

$$\frac{\lambda(\theta)}{1 - \beta\gamma(1 - \lambda(\theta))}\left(y^r(x) + \beta(1 - \gamma)\frac{d}{dx}\left(\mathbb{E}_y[\max\{M(x, y) - W^U(x, y), W^s(x) - R\}]\right) + x\frac{dy^r(x)}{dx}\right) + \frac{d(W^s(x) - R)}{dx} = 0 \quad (72)$$

Since $\frac{d(W^s(x) - R)}{dx} > 0$, this implies that

$$y^s(x) + x\frac{dy^s(x)}{dx} \geq y^r(x) + x\frac{dy^r(x)}{dx} + \frac{1 - \beta\gamma}{\lambda(\theta)}\frac{d(W^s(x) - R)}{dx}, \quad (73)$$

which implies that, evaluated at $x = 1$,

$$\frac{dy^s(x)}{dx} - \frac{dy^r(x)}{dx} > y^r(x) - y^s(x).$$

This means that for $y^r > y^s$, more occupational human capital brings closer the two cutoffs. For $y^r < y^s$, it holds in this simplified setting that y^r jumps to the corner, $y^r = \underline{y}$, while y^s is lowered for an increase in x . This completes the proof of Lemma 3.

Proof of Lemma 4 To proof this lemma we use the equations (19) - (23), where we have assumed no human capital accumulation. Further, to simplify we let $\gamma = 1$ such that the z -productivity does not change. We also focus on the case in which $z^r > z^s$ and without loss of generality let $\delta = 0$. In this environment, note that at labor markets whose z -productivity equals z^r (the reservation productivity for the reallocation decision) it holds that the value of reallocation equals the value of staying and searching in the current occupation,

$$\int_{\underline{z}}^{\bar{z}} W^U(p, z)dF(z) - c = W^U(p, z^r) + \lambda(\theta(p, z^r))(W^E(p, z^r) - W^U(p, z^r)). \quad (74)$$

In a stationary environment, described by p, z , the value of unemployment for workers with $z < z^r$ is given by $W^U(p, z) = W^U(p, z^r)$. This follows since over this range of z 's, $\int_{\underline{z}}^{\bar{z}} W^U(p, z)dF(z) - c \geq W^U(p, z) + S(p, z)$ and unemployed workers prefer to reallocate the period after arrival. On

the other hand, the value of unemployment for workers with $z \geq z^r$ is given by

$$W^U(p, z) = \frac{b + \beta\lambda(\theta(p, z))(W^E(p, z) - W^U(p, z))}{1 - \beta}.$$

Equation (74) can then be expressed as

$$\begin{aligned} & \beta \int_{\underline{z}}^{\bar{z}} \left(\max\{\lambda(\theta(p, z))(W^E(p, z) - W^U(p, z)), \lambda(\theta(p, z^r))(W^E(p, z^r) - W^U(p, z^r))\} \right) dF(z) \\ & = \lambda(\theta(p, z^r))(W^E(p, z^r) - W^U(p, z^r)) + c(1 - \beta). \end{aligned}$$

Using $\eta\lambda(\theta)(W^E(p, z) - W^U(p, z)) = (1 - \eta)\lambda(\theta)J(p, z) = (1 - \eta)\theta(p, z)k$, we have that $R(p) = W^U(p, z^r(p))$ can be expressed as

$$\frac{(1 - \eta)k}{\eta} \left(\beta \int_{\underline{z}}^{\bar{z}} \max\{\theta(p, z), \theta(p, z^r)\} dF(z) \right) - c(1 - \beta) = \frac{(1 - \eta)k}{\eta} \theta(p, z^r), \quad (75)$$

where the LHS describes the net benefit of reallocating to a different occupation and the RHS the benefit of staying in the same occupation. With this derivation we now analyse under what conditions $dz^r/dp > 0$ and compare it to the competitive case. The reservation z -productivity for the competitive and search case, satisfies, respectively,

$$\begin{aligned} & b + \beta \int_{\underline{z}}^{\bar{z}} \frac{\max\{y(p, z), y(p, z_c^r)\}}{1 - \beta} dF(z) - \frac{y(p, z_c^r)}{1 - \beta} - c_c = 0 \\ & \frac{(1 - \eta)k}{\eta} \left(\beta \int_{\underline{z}}^{\bar{z}} \frac{\max\{\theta(p, z), \theta(p, z^r)\}}{1 - \beta} dF(z) - \frac{\theta(p, z^r)}{1 - \beta} \right) - c_s = 0. \end{aligned}$$

With the Pissarides wage equation in hand,⁴⁷

$$w(p, z) = (1 - \eta)y(p, z) + \eta b + \beta(1 - \eta)\theta(p, z)k. \quad (76)$$

Using the free-entry condition and the Cobb-Douglas specification for the matching function we have that θ then solves

$$\theta(p, z)^{\eta-1} \frac{\eta(y(p, z) - b) - \beta(1 - \eta)\theta(p, z)k}{1 - \beta} - k \equiv E(\theta; p, z) = 0,$$

where differentiation implies that θ is increasing in both p and z ,

$$\frac{d\theta(p, z)}{dj} = \frac{\theta(p, z)}{w(p, z) - b} \frac{dy_j(p, z)}{dj}, \quad \text{for } j = p, z.$$

To make precise the comparison with an economy in which occupations are segmented in many competitive labor markets, consider the same environment as above, with the exception that workers can match instantly with firms. As before, we assume free entry (without vacancy costs), and constant returns to scale production. This implies that every worker will earn his marginal product

⁴⁷A formal derivation of this equation can be found in the Supplementary Appendix.

$y(p, z)$. Importantly, we keep the reallocation frictions the same: workers who reallocate have to forgo production for a period, and arrive at a random labor market in a different occupation at the end of the period. In the simple case of permanent productivity (p, z) , the value of being in a labor market with z , conditional on $y(p, z) > b$, is $W^c(p, z) = y(p, z)/(1 - \beta)$, where to simplify we have not consider job destruction shocks.

Block recursiveness, given the free entry condition, is preserved, so again, decisions are only functions of (p, z) . Unemployed workers optimally choose to reallocate, and the optimal policy is a reservation quality, z_c^r , characterised by the following equation

$$\beta \int \max\{y(p, z), y(p, z_c^r)\} dF(z) + (b - c)(1 - \beta) = y(p, z_c^r).$$

The LHS describes the net benefit of switching occupations, while the RHS the value of of staying employed earning y in the (reservation) labor market.

Using these equations, the response of the reservation z -productivity, for the competitive, and the frictional case, is then given by

$$\begin{aligned} \frac{dz_c^r}{dp} &= \frac{\beta F(z_c^r) \frac{y_p(p, z_c^r)}{y_z(p, z_c^r)} + \beta \int_{z_c^r}^{\bar{z}} \frac{y_p(p, z)}{y_z(p, z_c^r)} dF(z) - \frac{y_p(p, z_c^r)}{y_z(p, z_c^r)}}{1 - \beta F(z_c^r)} \\ \frac{dz^r}{dp} &= \frac{\beta F(z^r) \frac{y_p(p, z^r)}{y_z(p, z^r)} + \beta \int_{z^r}^{\bar{z}} \frac{\theta(p, z)(w(p, z^r) - b)}{\theta(p, z^r)(w(p, z) - b)} \frac{y_p(p, z)}{y_z(p, z^r)} dF(z) - \frac{y_p(p, z^r)}{y_z(p, z^r)}}{1 - \beta F(z^r)} \end{aligned}$$

These are the expression shown in Lemma 4, where note that $\frac{\theta(p, z)}{(w(p, z) - b)} \frac{(1 - \eta)k}{\eta} = \frac{\lambda(\theta(p, z))}{1 - \beta + \beta\lambda(\theta(p, z))}$ by virtue of (77) with $\delta = 0$. This completes the proof of Lemma 4.

With this result at hand we now show two implications. First we show that search frictions adds a procyclical force to reallocations. Choosing c_c, c_s appropriately such that $z_c^r = z^r$, the above expressions imply that $\frac{dz^r}{dp} > \frac{dz_c^r}{dp}$ if $\frac{\theta(p, z)}{w(p, z) - b} > \frac{\theta(p, z^r)}{w(p, z^r) - b}$, $\forall z > z^r$. Hence we now need to show that $\frac{\theta(p, z)}{w(p, z) - b}$ is increasing in z .

$$\frac{d\left(\frac{\theta(p, z)}{w(p, z) - b}\right)}{dz} = \frac{\theta y_z(p, z)}{(w(p, z) - b)^2} - \theta \left(\frac{(1 - \eta) + (1 - \eta)\beta \frac{\theta}{w(p, z) - b} k}{(w(p, z) - b)^2} \right) y_z(p, z),$$

which has the same sign as $\eta - (1 - \eta)\beta k \frac{\theta}{w(p, z) - b}$ and the same sign as

$$\begin{aligned} &\eta(1 - \eta)(y(p, z) - b) + \eta(1 - \eta)\beta\theta k - (1 - \eta)\beta\theta k \\ &= (1 - \eta)(\eta(y(p, z) - b) - (1 - \eta)\beta\theta k). \end{aligned}$$

But $\eta(y(p, z) - b) - (1 - \eta)\beta\theta k = y(p, z) - w(p, z) > 0$ and have established that search frictions within labor markets make reallocation more procyclical relative to the competitive benchmark, given the same $F(z)$ and the same initial reservation productivity $z^r = z_c^r$.

Second, we show that impact of the production function on the procyclicality of reallocation. Here we want to show that with search frictions, if the production function is modular or supermod-

ular (i.e. $y_{pz} \geq 0$), there exists a $c \geq 0$ under which reallocation is procyclical. With competitive markets, if the production function is modular, reallocation is countercyclical, for any $\beta < 1$ and $c \geq 0$.

Note that modularity implies that $y_p(p, z) = y_p(p, \tilde{z})$, $\forall z > \tilde{z}$; while supermodularity implies $y_p(p, z) \geq y_p(p, \tilde{z})$, $\forall z > \tilde{z}$. Hence modularity implies

$$\frac{dz_c^r}{dp} = \frac{1}{1 - \beta F(z_c^r)} \frac{y_p(p, z_c^r)}{y_z(p, z_c^r)} \left(\beta F(z_c^r) + \beta \int_{z_c^r}^{\bar{z}} \frac{y_p(p, z)}{y_p(p, z_c^r)} dF(z) - 1 \right) < 0, \forall \beta < 1.$$

In the case with frictions,

$$\frac{dz^r}{dp} = \frac{1}{1 - \beta F(z^r)} \frac{y_p(p, z^r)}{y_z(p, z^r)} \left(\beta F(z^r) + \beta \int_{z^r}^{\bar{z}} \frac{\theta(p, z)(w(p, z^r) - b)}{\theta(p, z^r)(w(p, z) - b)} \frac{y_p(p, z)}{y_p(p, z^r)} dF(z) - 1 \right).$$

If we can show that the integral becomes large enough, for c large enough, to dominate the other terms, we have established the claim. First note that $\frac{y_p(p, z)}{y_p(p, z^r)}$ is weakly larger than 1, for $z > z^r$ by the (super)modularity of the production function. Next consider the term $\frac{\theta(p, z)(w(p, z^r) - b)}{\theta(p, z^r)(w(p, z) - b)}$. Note that

$$\lim_{z \downarrow y^{-1}(b; p)} \frac{\theta(p, z)}{w(p, z) - b} = \frac{\lambda(\theta(p, z))}{1 - \beta + \beta \lambda(\theta(p, z))} = 0,$$

because $\theta(p, z) \downarrow 0$, as $y(p, z^r) \downarrow b$. Hence, fixing a z such that $y(p, z) > b$, $\frac{\theta(p, z)(w(p, z^r) - b)}{\theta(p, z^r)(w(p, z) - b)} \rightarrow \infty$, as $y(p, z^r) \downarrow b$. Since this holds for any z over which is integrated, the integral term becomes unboundedly large, making dz^r/dp strictly positive if reservation z^r is low enough. Since the integral rises continuously but slower in z^r than the also continuous term $\frac{\theta(p, z^r)}{1 - \beta}$, it can be readily be established that z^r depends continuously on c , and strictly negatively so as long as $y(p, z^r) > b$ and $F(z)$ has full support. Moreover, for some \bar{c} large enough, $y(p, \underline{z}^r) = b$. Hence, as $c \uparrow \underline{z}^r$, $\frac{dz^r}{dp} > 0$.

Appendix C

In this appendix we present evidence that motivates our focus on gross occupational mobility through unemployment. We also relate our findings to the literature on occupational mobility.

A Gross Versus Net Occupational Mobility

Here we present evidence suggesting that occupational-wide shocks do not seem to be the main driver behind gross occupational mobility of the unemployed or fluctuations in aggregate unemployment.

This evidence is based on comparing net mobility flows across occupations (i.e. the mobility generated as some occupations expand and others contract) with gross mobility flows. We find that gross occupational flows are at least 9 times larger than net flows, in the median. To measure the relative size of gross mobility flows we use $M_o = \frac{\min\{I_o, O_o\}}{|I_o - O_o|}$, where I_o denotes the inflow of workers into an occupation o and O_o the outflow from that occupation. Our data can be divided into three different sets of panels each sharing a coming occupational classification (see the Supplementary Appendix for details). For each of these sets, we rank each occupation by the size of their M_o and compute the median value. The number reported above is the average of these median values. This finding is consistent with Kambourov and Manovskii (2008). The measured difference between gross and net mobility implies that if an occupation decreases its size by one worker (through mobility involving an unemployment spell), it typically does so by losing 10 and gaining back 9 workers. This suggests that idiosyncratic rather than occupation-wide conditions are driving most of the occupational mobility of the unemployed.

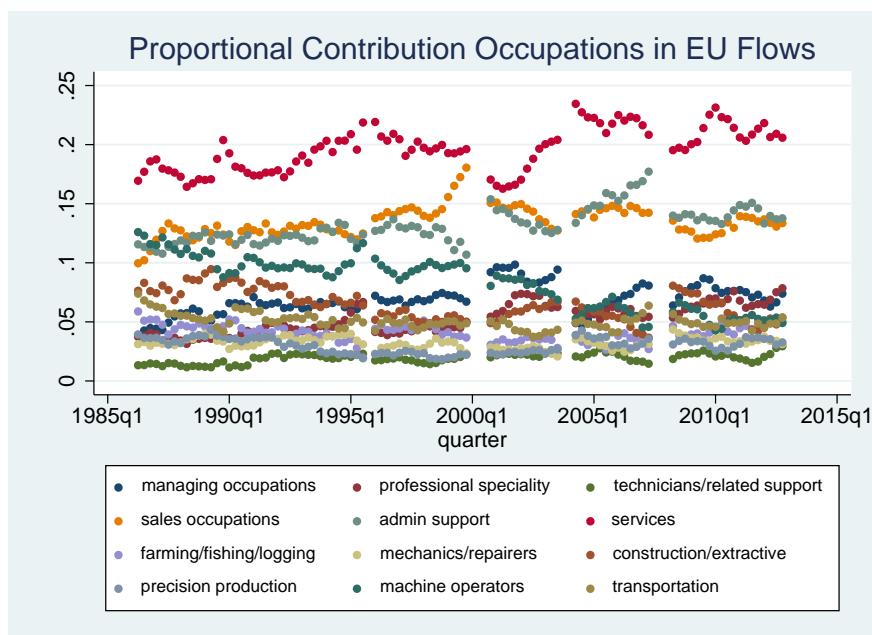

Figure 10: Noncumulative EU flows

When considering the cyclical behavior of occupational mobility of the unemployed, we find (over our sample period) that recessions are times where job separations are going up in all occupations, and job finding rates are going down in all occupations. This suggests that cyclical patterns in net mobility are not driving cyclical patterns in gross mobility. Concretely, we find that the occupational *composition* of the employment-to-unemployment (EU) and unemployment-to-employment (UE) flows does not appear to vary substantially over the business cycle. Figures 10 to 13 present this evidence using the SIPP data, after applying David Dorn’s crosswalk procedure to homogenize the different occupational classifications we use (see Dorn, 2009, and Autor and Dorn, 2013). Figure 10 shows the the share of each major occupation (from which the worker has separated) in the total EU flow over time. Figure 11 shows the same series but in a cumulative way, such that the difference between each two consecutive series gives the evolution of the share of the corresponding major occupation’s EU flows in the aggregate EU flow. Likewise for unemployment outflows, Figure 12 shows the evolution of the proportion of each major (hiring) occupation’s UE flow in the aggregate UE flow. Figure 13 again shows cumulatively the same series, such that the overall proportions add up to 1.

Figure 10 to 13 imply a number of interesting observations. They show that there is heterogeneity in terms of the relative size of EU and UE flows flows across occupations. This reflects in part that some occupations are bigger than others. We also observe an interesting time trend in the EU and UE flows, reflecting the long run changes in the relative size of these occupations. As we argued in the main text (see footnote 11), our model can be extended to incorporate these long run changes in occupational size by changing the occupational sampling distribution without affecting any of our results.

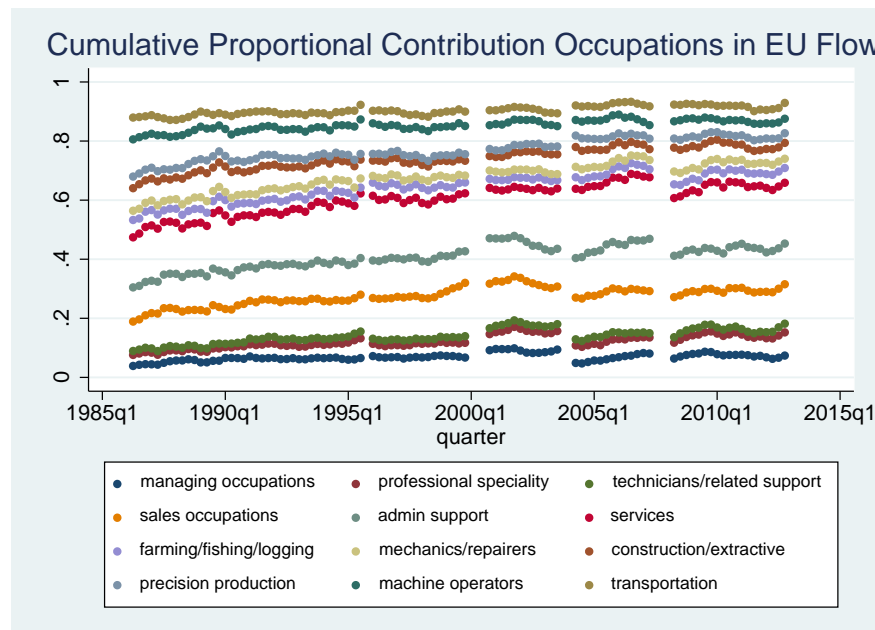

Figure 11: Cumulative EU flows

Crucially for our paper, these figures imply that there are no substantial differences across occupations in the cyclical variation of EU and UE flows. In particular, we generally do not observe that a subset of occupations increase their relative importance substantially in the aggregate EU flow, during the three recession covered in our sample. Likewise, we do not observe that a subset of occupations increase their relative importance in the aggregate UE flows through the period covered. Hence, this evidence shows that although EU flows increase in recession, the cyclical pattern of EU flows is not driven by particular occupations. In turn, this suggests that shocks to major occupational groups and hence net mobility of unemployed workers across occupations, do not play an important role in explaining the cyclical movements of unemployment.

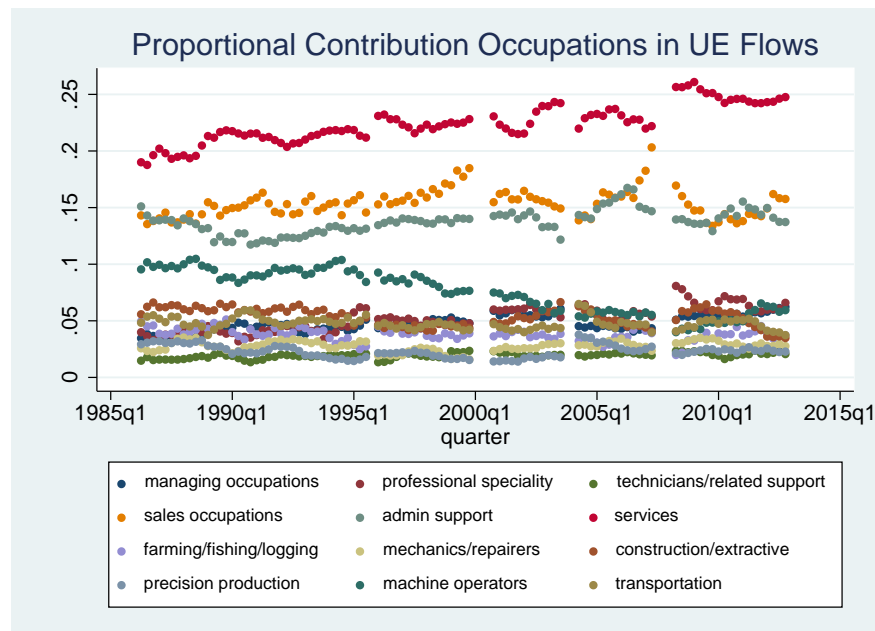

Figure 12: Noncumulative UE flows

An exception is the construction and extractive occupation category, which between 2008 and mid-2009 showed a larger increase in its EU flow, reflected in the widening gap in Figure 11. This episode seems isolated in terms of the period and the set of occupations studied. But, more importantly, it involves only a 5 percentage points increase in its share in the unemployment inflows, which means its impact on the overall unemployment rate is limited. Other patterns, if any, are of an even smaller magnitude. Our findings echo those of Kroft et al. (2013), who show that the rise in long-term unemployment during and after the Great Recession is not driven by shifts in occupational composition (see Figure A5 in the Appendix of their paper). It is also consistent with Shimer (2007), who argues that occupational mobility at business cycle frequencies is primarily for idiosyncratic reasons. Dvorkin (2013) shows that net mobility across industries cannot account for the majority of the fluctuations in aggregate unemployment. Likewise, Jovanovic and Moffitt (1990) and Auray et al. (2014) show that workers' mobility decisions across industries not

primarily driven by industry-wide shocks.

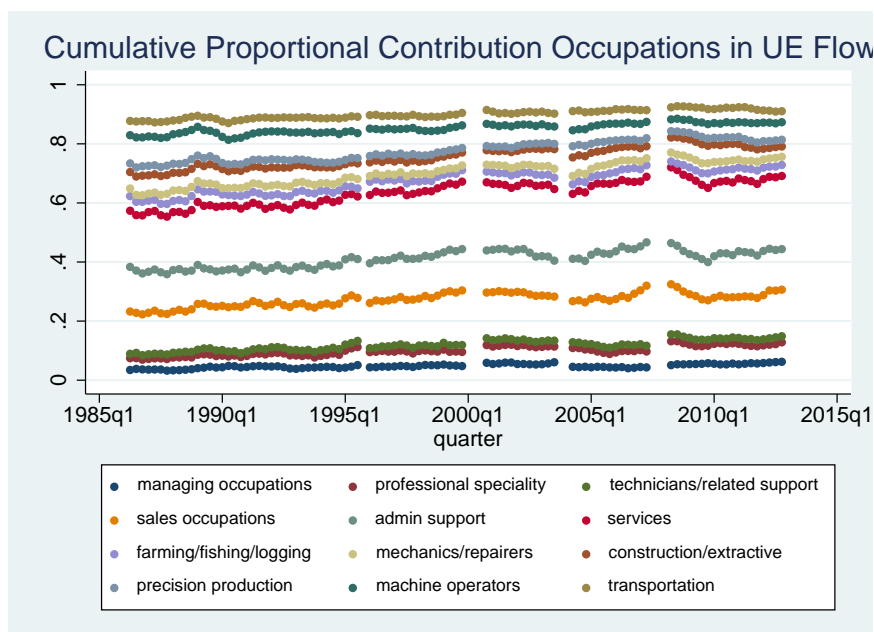

Figure 13: Cumulative UE flows

B Occupational Mobility Through Unemployment

The focus of this paper is on aggregate and individual unemployment outcomes and the role that occupational mobility can have in explaining these unemployment outcomes. This implies that the relevant data is one that gives direct information about the occupational mobility of the unemployed and not about overall occupational mobility. Interestingly, compared to employed workers, there is little documentation of the characteristics and impact on aggregate fluctuations of unemployed workers’ occupational mobility. In the case of employed workers, for example, Moscarini and Thomsson (2007), Moscarini and Vella (2008) and Kambourov and Manovskii (2008), document the extent of occupational mobility of employed workers and show that it is highly correlated with job-to-job transitions. Further, the nature of reallocation between employed and unemployed workers also seems to differ. While occupational mobility among the employed typically reflects career progression, this is not the case among those workers that lost their jobs and became unemployed (see Longhi and Taylor, 2011). Finally, we also think it is important to first understand the extent to which unemployed workers’ decisions to stay or reallocate affect aggregate unemployment fluctuations, as this can inform work that attempts measuring the impact of mismatch unemployment (see Şahin, et al., 2012 and Herz and Van Rens, 2011).

In terms of our theoretical framework, the z -productivity, as we model it, can be thought of capturing the component of the worker’s present value of *currently* being employed in his occupation that is orthogonal to aggregate productivity. We consider the worker’s value of employment and

unemployment in his occupation intrinsically linked, and hence z also captures the present value of unemployment component orthogonal to aggregate productivity. This expected value can incorporate as well the expected value of any future job-to-job transition (though not entirely perfectly), especially for those hires out of unemployment. Overall, the paper is focussed on the flows into and out of unemployment, the resulting unemployment distribution of durations, and the occupational mobility of the unemployed, over the business cycle. What is of first-order in what we are able to capture is (1) the causes of the inflow into unemployment – having a low output and, in general, the loss of any surplus of being employed in one’s occupation, (2) the causes of reallocation of the unemployed – having a nonviable productivity in one’s occupation, that could be remedied by moving to another occupation, and (3) the causes of outflows into employment – having a viable productivity in one’s current occupation. We believe that the z -productivity process captures the idiosyncratic (i.e. non-aggregate) component of these decisions very well in a parsimonious way, without the need to model explicitly the details of what happens during employment spells.

In Table 1, in the main text, we show there is a large degree of occupational change among unemployed workers. In earlier versions of this papers, we found that is shared across gender, and across education levels. We further investigate whether this result is driven by mobility to or from a few occupational categories. To do so, we compute transitions matrices for each of the three occupation classifications used during the entire period we study. These matrices are reported in Tables A.2 to A.4, in the Supplementary Appendix. On their diagonal, they show that, although there is some heterogeneity across major occupations on the probability of becoming an occupational mover/stayer, there is no subset of occupational groups that drives the extent of occupational mobility we observe at an aggregate level. Workers in all occupational groups present large degrees of mobility. Excluding executive, administrative and managerial, mobility statistics are not affected much. There are generally significant bidirectional flows (i.e. flows from occupation i to j compared to flows from j to i), indeed consistent with, as far as the transitions of the *unemployed* are concerned, an apparent absence of a clear career progression path through occupational mobility.

We do observe that unemployed workers that were previously employed in a given major occupational group tend to move with similar propensities to around five to seven different occupational groups, depending on the group of departure, years considered and classification used. This generates a seeming pattern of clustering (top left and bottom right) in the transition matrices, which appears to relate to educational differences among workers, with the lower-educated working in the more manual occupations at the bottom right. However, the overall mobility rate in unemployment across educational groups, or within these apparent clusters, appears to be remarkably similar. This applies even to the variation of the occupational mobility rate with age across the different education groups. As a result, this form of clustering by itself is not inconsistent with our model. (By scaling costs and benefits we can allow a representative worker construct along the cluster-dimension.) As mentioned in footnote 11, we can capture the movements of the transition matrix perfectly in our model by adjusting the sampling distribution across occupations accordingly, with-

out changing our results at all. For simplicity we assume a uniform sampling distribution across occupations.

Our focus has also been on the mobility of workers across occupations rather than industries. Using the SIPP we find that the main features that characterise workers' occupational mobility are very similar to those found when analysing their mobility across aggregate industrial categories. Indeed, the correlation between occupational and industrial mobility is quite high. However, since we are interested in understanding the role occupational productivity plays in shaping workers' reallocation decisions, our focus on occupations is motivated by Kambourov and Manovskii (2009a) as mentioned in the Introduction. Further, Kambourov and Manovskii (2009b) also show that in the US the returns to occupational experience are far more important than returns to industry experience (see also Williams, 2009, for evidence based on UK data). Finally, we consider 'major' categories to make it clear that occupational reallocation involves the loss of human capital.

C Relationship with the Occupational Mobility Literature

In the context of (our) existing knowledge, the mobility patterns reported in Section 2 are in line with and complement those documented in Murphy and Topel (1987) for mobility across industries in the US using the CPS for the period 1970-1985. They show that the incidence of unemployment is significantly higher for those workers who change industries and that mobility across industries is procyclical for these workers. Our results are also in line with Carrillo-Tudela, Hobijn and Visschers (2014) who document the procyclicality of the proportion of occupational movers out of unemployment in hires using the CPS for the period 1986-2011. There we find that on average 48.2% of all those unemployed workers who became employed at any given month changed their major occupations. When constructing a similar measure for the SIPP we obtain 41.7%. These comparisons are evidence that the extent of occupational reallocation through unemployed we find in the SIPP is also present in the CPS.

Our evidence is also consistent with that of Kambourov and Manovskii (2009b), using the PSID, Xiong (2008), using the SIPP, and Longhi and Taylor (2011), using the Labour Force Survey for the UK, who find that the extent of occupational mobility through unemployment is high (though their focus is not on behavior over the business cycle). Fujita and Moscarini (2012), using the SIPP, have found that those worker that experienced unemployment after being permanently separated from their previous jobs are much more likely to make an (3-digit) occupational change than those that were on layoff and recalled within 3 months. They also find that the likelihood of experiencing occupational change in this context increases with unemployment duration. Faberman and Kudlyak (2012) with data from an on-line job-search website, find that workers apply more to vacancies outside their usual occupational field as their spell duration increases.

Supplementary Appendix

A Occupational Mobility Data

A.1 Data Construction

The Survey of Income and Programme Participation (SIPP) is a longitudinal data set based on a representative sample of the US civilian non-institutionalized population. It is divided into multi-year panels. Each panel comprise a new sample of individuals and is subdivided into four rotation groups. Individuals in a given rotation group are interviewed every four months such that information for each rotation group is collected each month. At each interview individuals are asked, among other things, about their employment status as well as their occupations and industrial sectors during employment in the last four months.⁴⁸

There are several advantages of using the SIPP to other data sets like the Current Population Survey (CPS) or the Panel Study of Income Dynamics (PSID), which also have been used to measure labor market flows and/or occupational and sectoral mobility. The SIPP's longitudinal dimension, high frequency interview schedule and explicit aim to collect information on worker turnover allows us to construct reliable measures of occupational mobility and labor market flows. Further, its panel dimension allows us, compared to the CPS, to follow workers over time and construct uninterrupted spells of unemployment that started with an employment to unemployment transitions and ended in a transition to employment. It's panel dimension also allows us to analyse these workers' occupational mobility patterns conditional on unemployment duration and their post occupational (in) mobility outcomes as outlined in Section 2.⁴⁹

We consider the period 1986 - 2011. To cover this period we use the 1986-1988, 1990-1993, 1996, 2001, 2004 and 2008 panels. Although the SIPP started in 1984, our period of study reflects two considerations. The first one is methodological. Since 1986 the US Census Bureau has been using dependent interviewing in the SIPP's survey design, which helps to reduce measurement error problems. The second reason is that such a period allows us to study the behaviour of unemployment, labor market flows between unemployment and employment and occupational mobility during two recessions, the Great Moderation period and the Great Recession.

For the panels 1986-1988 and 1990-1993 we have used the Full Panel files as the basic data sets, but appended the monthly weights obtained from the individual waves. We have used the Full Panel files as the individual waves do not have clear indicators of the job identifier. Since the US Census Bureau does not provide the Full Panel file for the 1989 data set, which was discontinued and only three waves are available, we opted for not using this data set. This is at a minor cost as the

⁴⁸See <http://www.census.gov/sipp/> for a detailed description of the data set.

⁴⁹See Mazumder (2007), Fujita, Nekarda and Ramey (2007) and Nagypal (2008) for recent studies that document labor market flows and Xiong (2008) and Moscarini and Fujita (2012) for studies that document occupational mobility using the SIPP. To our knowledge there is no study that uses the SIPP to jointly study labor market flow, occupational mobility and its cyclical patterns.

1988 panel covers up to September 1989 and the 1990 panel collects data as from October 1989. For the panels 1996, 2001, 2004, 2008 there are no Full Panel files, but one can easily construct the full panel by appending the individual wave information using the individual identifier “lgtkey”. In this case, the job identifier information is clearly specified.

Two important differences between the post and pre-1996 panels are worth noting. The pre-1996 panels have an overlapping structure and a smaller sample size. Starting with the 1996 panel the sample size of each panel doubled in size and the overlapping structure was dropped. To overcome these differences and make the sample sizes somehow comparable, we constructed our pre-1996 indicators by obtaining the average value of the indicators obtained from each of the overlapping panels. On the other hand, the SIPP’s sample design implies that in *all* panels the first and last three months have less than 4 rotation groups and hence a smaller sample size. For this reason we only consider months that have information for all 4 rotation groups. The data also shows the presence of seams effects between waves. To reduce the seam bias we average the value of the indicator over the four months that involve the seam. Our indicators are based on the employment status variable at the second week of each month, “wesr2” for the 1986-1988 and 1990-1993 panels and “rwkesr2” for the 1996-2008 panels. The choice of the second week is to approximate the CPS reference week when possible.⁵⁰

For the 1986-2008 panels, we consider all workers between 16 and 65 years of age who are not in self-employment, government employment or in the armed forces. A worker is considered employed if the individual was (1) with job/business - working, (2) with job/business - not on layoff, absent without pay and (3) with job/business - on layoff, absent without pay. A worker is considered unemployed if the individual was with (4) no job/business - looking for work or on layoff. A worker is then considered out of the labor force (non-participant) if he/she was with (5) no job/business - not looking for work and not on layoff. Under this classification we exclude those workers that are still with a job but on layoff, miss those workers on layoff who were not recalled and changed employers and include those workers that experienced a permanent separation and where recall by their previous employers. Moscarini and Fujita (2012), using the SIPP for a similar period, find that the latter two types of workers represent a small proportion of those workers without a current job (on layoff or permanently separated).

The SIPP collects information on a maximum of two jobs an individual might hold simultaneously. For each of these jobs we have information on, among other things, hours worked, total earnings, 3-digit occupation and 3-digit industry codes. If the individual did hold two jobs simultaneously, we consider the main job as the one in which the worker spent more hours. We break a possible tie in hours by using total earnings. The job with the highest total earnings will then be considered the main job. In most cases individuals report to work in one job at any given moment.

⁵⁰See Fujita, et al. (2007) for a similar approach. We have also performed our analysis by constructing the labor market status of a worker based on the employment status monthly recode variable for all panels and our results do not change.

In the vast majority of cases in which individuals report two jobs, the hours worked are sufficient to identify the main job. Once the main job is identified, the worker is assigned the corresponding two, three or four digit occupation.⁵¹

The SIPP uses the Standard Occupational Code (SOC). The 1986-1993 panels use the 1980 SOC classification, while the 1996 and 2001 panels use the 1990 SOC classifications. These two classifications differ only slightly between them. The 2004 and 2008 panels use the 2000 SOC classification, which differs more substantially from the previous classifications. Since we find continuity in both the levels and cyclical patterns, we consider the full 1986-2011 period as our benchmark. At each step, we calculate a separate set of statistics spanning the 1986-2001 panels for robustness purposes, but have not find substantial differences, unless explicitly noted. We aggregate the information on “broad” occupations (3-digit occupations) provided by the SIPP into “minor” and “major” occupational categories.⁵²

Using the derived labor market status indicators and main job indicators we measure occupational mobility in two ways: (i) by comparing the reported occupation at re-employment with the one performed immediately before the unemployment spell and (ii) by comparing the reported occupation at re-employment with all those occupations the individual had performed in past jobs. The results presented in the paper are based on the first method for two reasons. This distinction only had a minor effect our results. In particular, for our repeat mobility statistics we find that the proportion of repeat-unemployed workers who *changed* occupations in their initial spell is sensitive to the definition of occupations held before the first occupational move in the data, ranging from 46%-56%. A reason for this sensitivity is that we are purposefully very harsh in selecting repeated spells of unemployment and the number of spells is somewhat small. Since we need to assign the second spell to occupational move/stay, the spell needs to be complete; then, since short spells are more likely to be stays, we require that at the beginning of the second spell, the worker remains in sample for at least another year. This issue does not change much the proportion of stayers in an unemployment spell following a spell with an occupational stay, and does not affect overall mobility statistics.

For (time-averaged) statistics calculated over the full SIPP dataset (1986-2011) we want to focus on the set of unemployment spells that we can assign the occupational mobility unambiguously. For time series (cyclical patterns), we do not take into account occupations not immediately preceding the unemployment spell, as the length of the available data history varies between the start and end of a panel, and could create spurious patterns. Since the occupational data is collected only when the worker is employed, this procedure is valid only for job changes (with an interven-

⁵¹For the 1990-1993 panels we correct the job identifier variable following the procedure suggested by Stinson (2003).

⁵²In any of these classifications we have not included the Armed Forces. The 1980 and 1990 classifications can be found in <http://www.census.gov/hhes/www/ioindex/pdfio/techpaper2000.pdf>. The 2000 classification can be found in <http://www.bls.gov/soc/socguide.htm>. Additional information about these classifications can be found at <http://www.census.gov/hhes/www/ioindex/faqs.html>.

ing unemployment spell) after the first observed employment spell. For these cases, we assume that after an employment spell, the unemployed worker retains the occupation of the last job and stays with it until he/she re-enters employment, were the worker might perform a new occupation. Under this procedure we have allowed the unemployed worker to keep his/her occupation when he/she undergoes an intervening spell of non-participation that leads back to unemployment. If this spell of non-participation leads directly to employment, however, we do not count this change as it does not involve an unemployment to employment transition. We also have allowed the worker to retain his/her occupation if the employment spell is followed by a spell of non-participation that leads into unemployment. In summary, the worker retains his/her occupation for transitions of the type: E-U-E, E-U-NP-U-E, E-NP-U-E or combinations of these; and does not retain his/her occupation for transitions of the type: E-NP-E, E-U-NP-E or combinations of these. For unemployment spells that precede the first employment spell we have not imputed an occupation and left it as missing to avoid over representing non-occupational movers in our sample.

We construct monthly time series for the unemployment rate, employment to unemployment transition rate (job separation rate), unemployment to employment transition rate (job finding rate), occupational mobility rates and the other measures described in the main text. Since there are months for which the SIPP does not provide data and we do not take into account months with less than 4 rotation groups, we have breaks in our time series. To cover the missing observations we interpolate the series using the TRAMO (Time Series Regression with ARIMA Noise, Missing Observations and Outliers) procedure developed by Gomez and Maravall (1999).⁵³ The periods with breaks are between 1989Q3-1989Q4, 1995Q4-1996Q1, 1999Q4-2000Q4, 2003Q4-2004Q1 and 2007Q4-2008Q2. To construct the occupational mobility rates, however, we left out the last 8 months of each panel. Not doing so would have biased downward this measure towards the end of the panel, as occupational stayers have a higher outflow rate than occupational movers.

A.2 Occupational Mobility Measures

We construct our measure of occupational mobility as the proportion of the unemployment outflow that starts employment in a different occupation than the one held before becoming unemployed. In particular, we compute the number of workers that became unemployed sometime in the past and found a job at time t in the future, $Ujob_t$. We then computed the number of workers that became unemployed sometime in the past and found a job at time t in a different occupation, Um_t . Our measure of occupational mobility is then the ratio $Cm_t = Um_t/Ujob_t$, where we measure it in the period in which the worker *left* unemployed. We use this measure to compute Table 1 and the repeat mobility statistics. We also computed the proportion of unemployed workers with n months of unemployment duration that eventually will find a job in a different occupation. We use this proportion to compute Figures 1 and 2 and Table 2. We also computed the outflow rate of occupational movers, Pm_t , which equals to UEm_t/Um_t , where UEm_{t+1} denotes the number

⁵³See also Fujita, et al. (2007) for a similar procedure using the SIPP.

of unemployed workers at month t that found a job in a different occupation the following month, $t + 1$. $P s_t$ is the analogous outflow rate for stayers. Further, we obtain $f_t = U job_t / U_t$.

Given the interpolated series, we seasonally adjust them using the Census Bureau X12 program. The cyclical components of these series are obtained by de-trending the log of each of these series based on quarterly averages and using the HP filter with smoothing parameter 1600. The same filter is applied to the simulated series in the quantitative section of the paper. Our working series are not adjusted for time aggregation error. The main reason for this choice is that when using the now ‘standard’ method to correct for time aggregation bias proposed by Shimer (2012) and extended by Elsby et al. (2009) and Fujita and Ramey (2009), one can only get closed form solution for the adjusted job finding and separation rates when only considering changes between two states (for example, employment and unemployment). Correcting for time aggregation when taking into account for occupational changes then becomes extremely cumbersome. Using Fujita and Ramey’s (2009) extension, however, we find that time aggregation has little effect on the cyclical behaviour of the aggregate job finding and separation rates in the SIPP.⁵⁴ We use a similar procedures to construct Table 2. In particular, in that table output refers to the seasonally adjusted series of non-farm business output provided by the BLS. Output per worker is constructed using this output measure and the seasonally adjusted employment series from the CPS obtained from the BLS website, <http://www.bls.gov>. Both series are for the 1986-2011 period to keep in line with the sample period we consider in the SIPP. We seasonally adjust all series using the Census Bureau X12 program. Their cyclical components are obtained by de-trending the log of each of these series based on quarterly averages and using the HP filter with smoothing parameter 1600.

B Omitted Theoretical Material

B.1 Derivation of the ‘Pissarides wage equation’

To derive this equation we use the stationary setting described in Appendix B of the paper and associated value functions (19) - (23). Given that an employed worker value in steady state is

$$W^E(p, z) = w(p, z) + \beta(1 - \delta)W^E(p, z) + \beta\delta W^U(p, z),$$

then

$$W^E(p, z) - W^U(p, z) = w(p, z) - b - \beta\lambda(\theta(p, z))(W^E(p, z) - W^U(p, z)) + \beta(1 - \delta)(W^E(p, z) - W^U(p, z)),$$

or

$$W^E(p, z) - W^U(p, z) = \frac{w(p, z) - b}{1 - \beta(1 - \delta) + \beta\lambda(\theta(p, z))}.$$

⁵⁴Fujita et al. (2007) arrived to a similar conclusion when analysing aggregate job finding and separations rates using the SIPP for the period 1983-2003.

From the combination of the free entry condition and the Hosios condition, we have

$$\eta \frac{w(p, z) - b}{1 - \beta(1 - \delta) + \beta\lambda(\theta(p, z))} = (1 - \eta)k/q(\theta(p, z)). \quad (77)$$

Moreover, from the value of the firm, we have

$$\frac{k}{q(\theta(p, z))} = \frac{y(p, z) - w(p, z)}{1 - \beta(1 - \delta)}$$

Solving the latter equation for $w(z)$ gives

$$w(p, z) = y(p, z) - \frac{k}{q(\theta(p, z))}(1 - \beta(1 - \delta)).$$

Substituting this in (77), we find

$$\eta(y(p, z) - b) - \frac{k}{q(\theta(p, z))}(1 - \beta(1 - \delta)) - \beta\theta(p, z)(1 - \eta)k = 0.$$

If we replace the middle term with $y(p, z) - w(p, z)$, we get the desired wage equation,

$$w(p, z) = (1 - \eta)y(p, z) + \eta b + \beta(1 - \eta)\theta(p, z)k.$$

B.2 Derivation of the slope of z^s for the case $z^r(p) > z^s(p)$ for all p

Note that $R(p) = \frac{b + \beta\theta(p, z^r(p))k(1 - \eta)/\eta}{1 - \beta}$. The derivative of this function with respect to p equals

$$\frac{\beta k(1 - \eta)}{(1 - \beta)\eta} \frac{\theta}{w(p, z^r(p)) - b} \left(y_p(p, z^r(p)) + y_z(p, z^r(p)) \frac{dz^r(p)}{dp} \right). \quad (78)$$

Since $w(p, z^r(p)) - b = (W^E(p, z^r(p)) - W^U(p, z^r(p)))(1 - \beta(1 - \delta) + \beta\lambda(\theta(p, z^r(p))))$ and $\frac{\theta\beta k(1 - \eta)}{(1 - \beta)\eta} = \beta\lambda(\theta(p, z^r(p)))(W^E(p, z^r(p)) - W^U(p, z^r(p)))$, we find that (78) reduces to

$$\frac{\beta\lambda(\theta(p, z^r(p)))}{1 - \beta(1 - \delta) + \beta\lambda(\theta(p, z^r(p)))} \left(y_p(p, z^r(p)) + y_z(p, z^r(p)) \frac{dz^r(p)}{dp} \right). \quad (79)$$

From the cutoff condition for separation, we find $(1 - \beta)R(p) = y(p, z^s(p))$. Taking the derivative with respect to p implies the left side equals (79) and the right side equals $y_p(p, z^s(p)) + y_z(p, z^s(p)) \frac{dz^s(p)}{dp}$. Rearranging yields the equation in the text.

		Table A1: Major Occupational Categories		
		1980	1990	2000
1	Executive, Admin., Managerial	Executive, Admin., Managerial	Management	
2	Professional Speciality	Professional Speciality	Business and Financial Operations	
3	Technicians and Related Support	Technicians and Related Support	Computer and Mathematical	
4	Sales	Sales	Architecture and Engineering	
5	Admin. Support, incl Clerical	Admin. Support, incl Clerical	Life, Physical, and Social Science	
6	Private Household	Private Household	Community and Social Services	
7	Protective Services	Protective Services	Legal	
8	Service, except Protective - Household	Service, except Protective - Household	Education, Training, and Library	
9	Farm, Forestry and Fishing	Farm, Forestry and Fishing	Arts, Design, Ent., Sports, Media	
10	Precision Production, Craft and Repair	Precision Production, Craft and Repair	Healthcare Practitioners and Tech.	
11	Machine Oper., Assemblers, Insp	Machine Oper., Assemblers, Insp	Healthcare Support	
12	Transportation and Material Moving	Transportation and Material Moving	Protective Service	
13	Handlers, Equip. Cleaners, Helpers, Lab.	Handlers, Equip. Cleaners, Helpers, Lab.	Food Preparation, Serving Rel.	
14			Building, Grounds Cleaning, Maint.	
15			Personal Care and Service	
16			Sales and Related	
17			Office, Admin. Support	
18			Farming, Fishing, and Forestry	
19			Construction and Extraction	
20			Installation, Maintenance, and Repair	
21			Production	
22			Transportation and Material Moving	

Table A.2: Transition Matrix 1980 SOC, 1986-1993

	1	2	3	4	5	6	7	8	9	10	11	12	13
1	0.365	0.062	0.014	0.143	0.196	0.001	0.006	0.073	0.038	0.031	0.020	0.040	0.011
2	0.064	0.529	0.053	0.074	0.094	0.000	0.005	0.057	0.065	0.026	0.012	0.018	0.006
3	0.036	0.130	0.430	0.037	0.101	0.000	0.000	0.095	0.083	0.046	0.008	0.026	0.008
4	0.046	0.025	0.005	0.450	0.125	0.006	0.007	0.143	0.041	0.059	0.016	0.063	0.015
5	0.055	0.021	0.016	0.121	0.537	0.002	0.003	0.107	0.030	0.046	0.013	0.047	0.004
6	0.000	0.014	0.000	0.122	0.081	0.360	0.000	0.323	0.048	0.000	0.015	0.037	0.000
7	0.011	0.008	0.000	0.091	0.030	0.000	0.273	0.156	0.091	0.065	0.156	0.091	0.030
8	0.017	0.020	0.005	0.118	0.068	0.005	0.012	0.499	0.057	0.059	0.024	0.098	0.017
9	0.014	0.011	0.009	0.050	0.024	0.000	0.015	0.057	0.563	0.086	0.038	0.110	0.024
10	0.009	0.014	0.005	0.060	0.050	0.003	0.005	0.099	0.111	0.489	0.041	0.089	0.025
11	0.004	0.006	0.000	0.040	0.020	0.005	0.021	0.056	0.113	0.058	0.548	0.104	0.026
12	0.010	0.012	0.009	0.068	0.069	0.001	0.012	0.095	0.122	0.100	0.048	0.413	0.041
13	0.000	0.009	0.000	0.031	0.026	0.002	0.003	0.075	0.053	0.075	0.040	0.105	0.581

Table A.3: Transition Matrix 1990 SOC, 1996-2001

	1	2	3	4	5	6	7	8	9	10	11	12	13
1	0.355	0.091	0.017	0.126	0.180	0.000	0.009	0.086	0.012	0.040	0.026	0.012	0.044
2	0.076	0.520	0.057	0.070	0.090	0.000	0.003	0.087	0.006	0.028	0.024	0.004	0.034
3	0.020	0.125	0.370	0.052	0.137	0.000	0.011	0.102	0.018	0.083	0.047	0.016	0.019
4	0.055	0.032	0.012	0.401	0.157	0.004	0.008	0.154	0.019	0.037	0.037	0.017	0.067
5	0.074	0.032	0.024	0.151	0.473	0.005	0.010	0.115	0.010	0.027	0.036	0.009	0.034
6	0.032	0.028	0.000	0.182	0.120	0.191	0.000	0.271	0.023	0.013	0.042	0.000	0.097
7	0.016	0.026	0.000	0.155	0.051	0.000	0.330	0.068	0.033	0.066	0.077	0.013	0.166
8	0.024	0.020	0.007	0.143	0.066	0.009	0.008	0.514	0.018	0.045	0.045	0.023	0.080
9	0.026	0.014	0.009	0.040	0.066	0.000	0.013	0.088	0.395	0.141	0.120	0.035	0.053
10	0.022	0.024	0.009	0.075	0.045	0.001	0.006	0.072	0.018	0.440	0.104	0.052	0.131
11	0.020	0.005	0.023	0.061	0.064	0.010	0.010	0.123	0.043	0.119	0.353	0.046	0.124
12	0.018	0.008	0.004	0.035	0.048	0.000	0.005	0.077	0.034	0.115	0.089	0.456	0.109
13	0.017	0.006	0.003	0.098	0.050	0.001	0.002	0.123	0.064	0.125	0.108	0.069	0.334

Table A.4: Transition Matrix 2000 SOC, 2004-2008

1	0.309	0.081	0.030	0.014	0.004	0.008	0.008	0.005	0.013	0.015	0.023	0.007	0.048	0.005	0.024	0.153	0.126	0.012	0.021	0.009	0.060	0.22
2	0.074	0.258	0.031	0.021	0.000	0.000	0.000	0.029	0.003	0.016	0.045	0.007	0.024	0.017	0.000	0.085	0.298	0.008	0.000	0.013	0.013	0.057
3	0.016	0.055	0.378	0.026	0.000	0.000	0.000	0.019	0.011	0.000	0.000	0.007	0.052	0.000	0.000	0.093	0.110	0.002	0.004	0.062	0.119	0.045
4	0.061	0.053	0.015	0.457	0.009	0.000	0.016	0.000	0.016	0.014	0.014	0.000	0.000	0.009	0.000	0.039	0.041	0.016	0.115	0.066	0.016	0.044
5	0.070	0.012	0.041	0.281	0.253	0.028	0.000	0.000	0.000	0.070	0.042	0.000	0.060	0.000	0.000	0.034	0.070	0.000	0.000	0.000	0.040	0.000
6	0.081	0.000	0.000	0.000	0.026	0.298	0.000	0.034	0.091	0.000	0.030	0.000	0.055	0.000	0.026	0.071	0.181	0.000	0.000	0.000	0.019	0.088
7	0.028	0.160	0.000	0.000	0.000	0.052	0.544	0.000	0.000	0.000	0.000	0.000	0.036	0.000	0.000	0.040	0.140	0.000	0.000	0.000	0.000	0.000
8	0.037	0.094	0.009	0.010	0.012	0.009	0.000	0.384	0.000	0.019	0.019	0.000	0.043	0.000	0.043	0.126	0.156	0.000	0.005	0.000	0.000	0.034
9	0.074	0.011	0.000	0.012	0.000	0.021	0.000	0.068	0.453	0.014	0.010	0.030	0.024	0.000	0.005	0.111	0.101	0.000	0.018	0.000	0.009	0.038
10	0.029	0.013	0.000	0.000	0.006	0.036	0.000	0.025	0.000	0.556	0.099	0.000	0.037	0.007	0.000	0.029	0.141	0.000	0.000	0.000	0.020	0.000
11	0.009	0.000	0.000	0.000	0.000	0.004	0.000	0.016	0.003	0.069	0.444	0.012	0.043	0.066	0.098	0.056	0.096	0.000	0.007	0.013	0.035	0.030
12	0.000	0.020	0.000	0.000	0.000	0.016	0.000	0.000	0.000	0.000	0.020	0.370	0.086	0.018	0.038	0.128	0.090	0.000	0.070	0.000	0.023	0.123
13	0.011	0.004	0.002	0.001	0.001	0.000	0.000	0.005	0.004	0.005	0.011	0.003	0.466	0.028	0.018	0.153	0.097	0.004	0.037	0.015	0.037	0.098
14	0.004	0.000	0.000	0.000	0.000	0.000	0.000	0.004	0.006	0.006	0.003	0.014	0.049	0.366	0.014	0.121	0.065	0.045	0.096	0.016	0.097	0.095
15	0.023	0.012	0.000	0.000	0.000	0.007	0.000	0.019	0.011	0.011	0.058	0.020	0.088	0.044	0.321	0.119	0.169	0.000	0.007	0.008	0.022	0.060
16	0.033	0.017	0.016	0.004	0.005	0.002	0.001	0.008	0.010	0.004	0.016	0.010	0.127	0.023	0.023	0.412	0.164	0.001	0.021	0.014	0.048	0.040
17	0.027	0.042	0.012	0.013	0.001	0.005	0.007	0.010	0.018	0.010	0.014	0.005	0.067	0.033	0.013	0.137	0.441	0.008	0.019	0.017	0.044	0.058
18	0.000	0.000	0.007	0.000	0.005	0.000	0.000	0.000	0.000	0.005	0.000	0.000	0.002	0.051	0.013	0.023	0.015	0.637	0.046	0.018	0.065	0.115
19	0.006	0.001	0.000	0.002	0.000	0.000	0.000	0.000	0.000	0.001	0.002	0.010	0.034	0.035	0.002	0.019	0.023	0.011	0.648	0.049	0.061	0.096
20	0.000	0.000	0.000	0.014	0.000	0.000	0.000	0.006	0.000	0.000	0.009	0.002	0.028	0.079	0.000	0.061	0.041	0.015	0.130	0.422	0.094	0.098
21	0.017	0.006	0.012	0.011	0.010	0.001	0.000	0.006	0.005	0.000	0.012	0.007	0.049	0.046	0.012	0.060	0.066	0.015	0.090	0.019	0.409	0.147
22	0.003	0.006	0.000	0.000	0.000	0.002	0.000	0.003	0.002	0.004	0.008	0.022	0.060	0.050	0.005	0.072	0.083	0.025	0.086	0.025	0.097	0.449